

FQ

Vision Sensor

SHORT MANUAL

OMRON

Table of Contents

1. Introduction

1-1 FQ-series Vision Sensors	4
1-2 Measurement Process	5
1-3 Startup Display and Display Elements	6
1-4 Basic Operational Flow	8

2. Installation and Connections

2-1 System Configuration	10
2-2 Installation	11
2-3 Wiring	15
2-4 Setting Up Ethernet	20

3. Taking Images

3-1 Selecting a Sensor for Configuration	24
3-2 Adjusting Image Quality	25
3-3 Adjusting the Object Position	30

4. Setting Up Inspections

4-1 Inspection Item Selection Guide	34
4-2 Setup Procedure for Inspection Items	35
4-3 Inspecting with the Search Inspection Item	36
4-4 Inspecting with the Edge Position Inspection Item	38
4-5 Inspecting with the Edge Width Inspection Item	40
4-6 Inspecting with the Area Inspection Item	42
4-7 Inspecting with Color Data Inspection Item	44

5. Testing and Saving Settings

5-1 Performing Test Measurements	48
5-2 Adjusting the Judgement Parameters	49
5-3 Checking a List of All Inspection Item Results	51
5-4 Saving Data to the Sensor	52

6. Operation

6-1 Starting Operation.....	54
6-2 Configuring the Run Mode Display.....	56
6-3 Adjusting Judgement Parameters during Operation.....	58

7. Communications with External Devices

7-1 Operation with Default Configuration.....	60
7-2 Setting the Measurement Trigger.....	61
7-3 Setting the Outputs.....	65
7-4 Controlling the Sensor from an External Device.....	68
Revision History.....	74

Introduction

1-1 FQ-series Vision Sensors	4
1-2 Measurement Process	5
1-3 Startup Display and Display Elements	6
1-4 Basic Operational Flow	8

1-1 FQ-series Vision Sensors

FQ-series Vision Sensors are real-color Vision Sensors with integrated processing. Once configured, they are used stand-alone for quality inspection of presence, position, and other product characteristics. To set up or monitor the sensors, either the touch screen based console 'Touch Finder' or a 'PC Tool' can be used.

FQ Vision Sensor

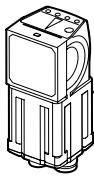

Includes the camera, lighting, measurement processor, and I/O functions. After the Sensor has been set up, it can be operated alone to perform measurements without the Touch Finder or PC Tool.

Setup, Image Confirmation, and Logging Tools

Touch Finder

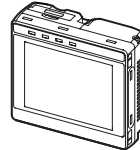

Used to check images and set the judgement parameters. It can also be used to save measurement results and check status during operation.

PC Tool



The same functions as those that are provided by the Touch Finder can be performed from a computer. The PC Tool is available free of charge.

FQ-series Vision Sensors are available in two different models. The differences are given in the following table.

Model	Standard model	Single-function model
Model number	FQ-S2□□□□□□	FQ-S1□□□□□□
Number of simultaneous measurements	32	1
Number of registered scenes	32	8
Position compensation	Supported	Not supported

1-2 Measurement Process

This section describes the basic flow of the measurement process.

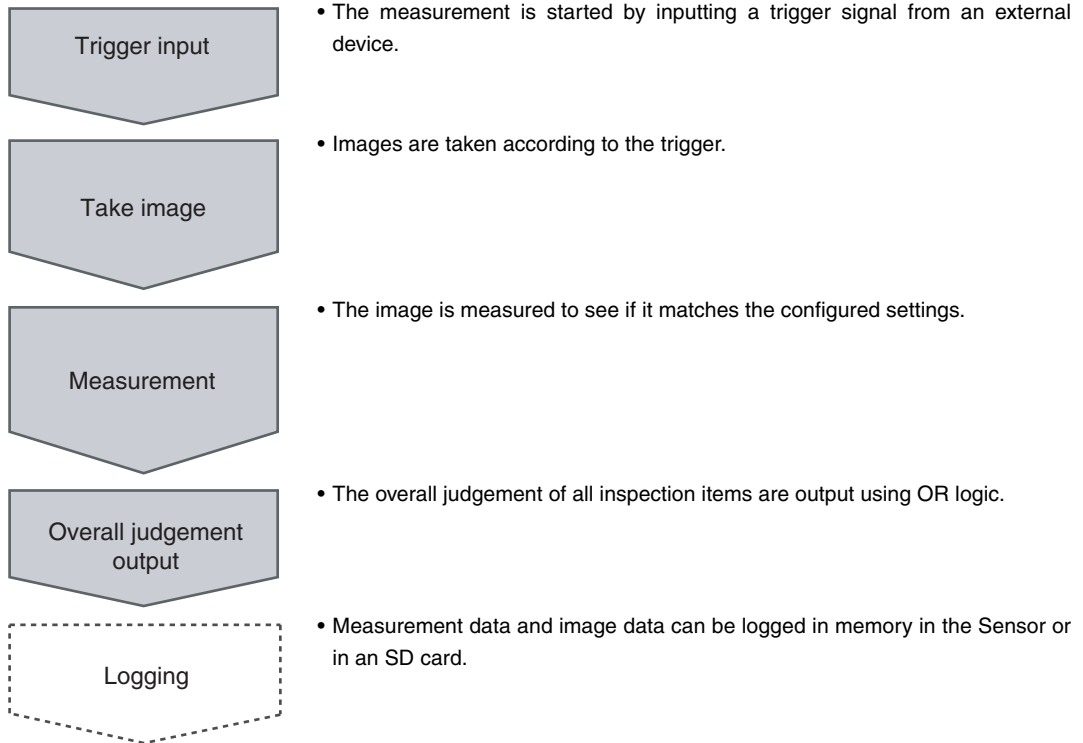

1-3 Startup Display and Display Elements

Startup Display

- 1 The Sensor is automatically detected by the Touch Finder when power supply to the Sensor and Touch Finder is turned ON.**

The Auto Connect Display will appear if the Sensor cannot be detected. Check that cables are connected correctly to the Sensor and Touch Finder, and then press [Auto connect].



- 2 When the Sensor is detected, the following display will appear.**

- The Setup Mode will appear if a Sensor that has not been set up is connected.
- The Run Mode will appear if a Sensor that has been set up is connected.

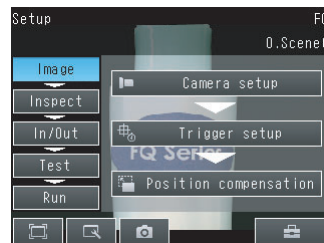

Note

When the Touch Finder is started, IP addresses are automatically set for each Sensor. To allocate specific IP addresses, set the IP address of each Sensor and the Touch Finder.

 Setting Up Ethernet: p. 20

Display Elements

This Sensor has a Setup Mode and a Run Mode.

Setup Mode

In Setup Mode, you can set the image conditions, judgement parameters, and I/O settings for the Sensor.

The name of the mode or the menu hierarchy is displayed.

The name of the Sensor being set up is displayed.

The selected scene number is displayed.

The menu changes according to the selected tab page.

- Buttons will appear on the right according to the mode.
- If the [◀] Button appears, pressing it will display the sub-menu or commands.

The setup flow is shown by these five tabs.

[Image]: Used to adjust the image.

[Inspect]: Used to set the inspection items.

[In/Out]: Used to set the I/O.

[Test]: Used to test and adjust the set measurements.

[Run]: Used to switch to Run Mode.

This button menu is always displayed.

- Only-image Button: Used to select either displaying the camera image and messages, or only the camera image.
- Display Button: Used to select the source of the image or to zoom the image.
- Capture Button: Used to capture the current screen to the SD card.
- Tool Button: Used to call functions, such as saving data or select scenes.

Note

The Display Button can be used to switch between the following images.

- Live: The live image is displayed.
- Freeze: The image that was taken last is displayed.
- Log: An image saved in internal memory is displayed.
- File: An image saved on an SD card is displayed.

Run Mode

In Run Mode, measurements are performed, and measurement results are output.

p. 53

1-4 Basic Operational Flow

The following flow shows the basic operation of FQ-series Vision Sensors.

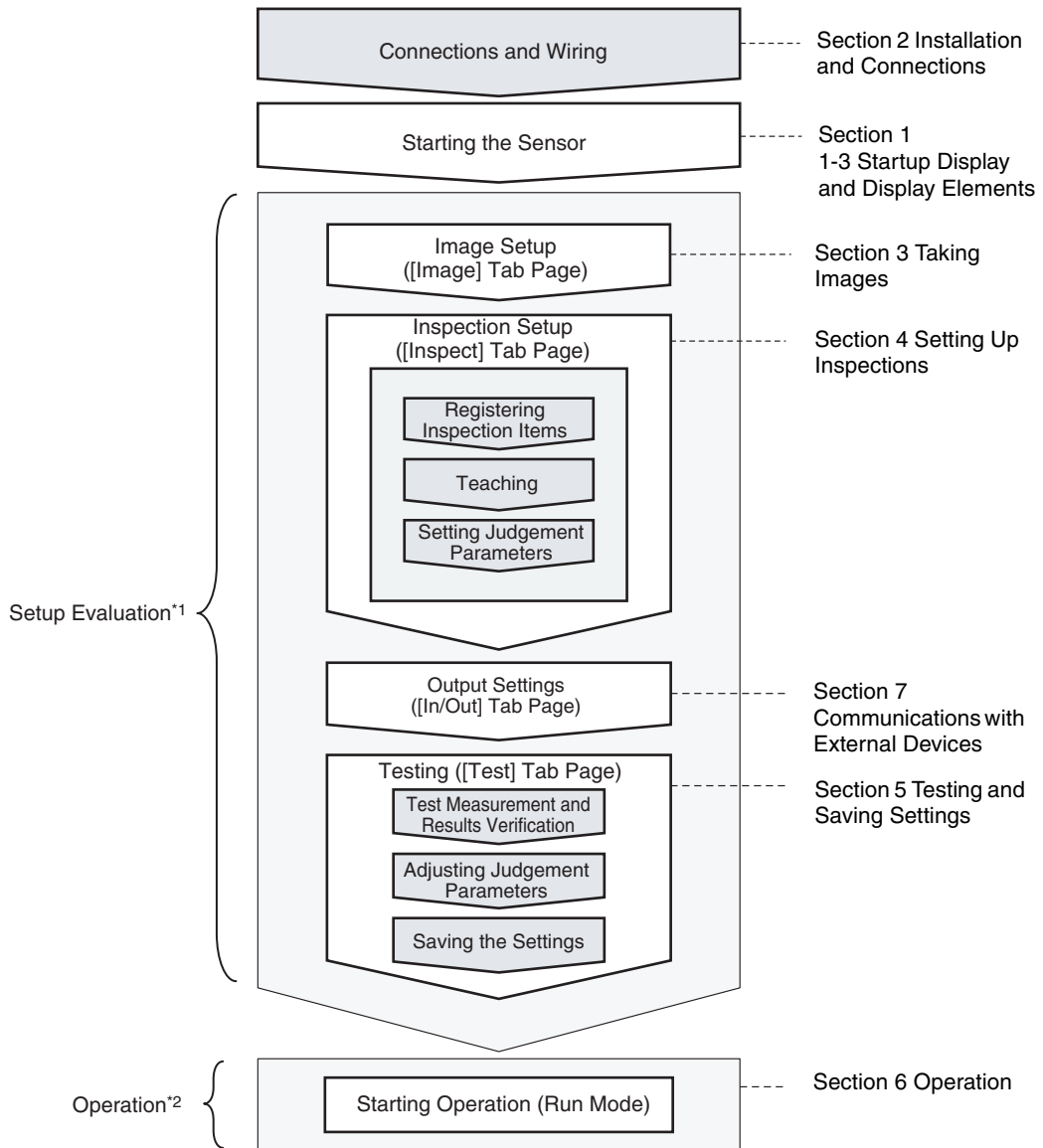

*1: In Setup Mode, the Sensor can be set up and adjusted, but it does not output signals on the I/O lines.

*2: In Run Mode, the Sensor performs measurements and outputs signals on the I/O lines.

Installation and Connections

2-1 System Configuration	10
2-2 Installation	11
2-3 Wiring	15
2-4 Setting Up Ethernet	20

2-1 System Configuration

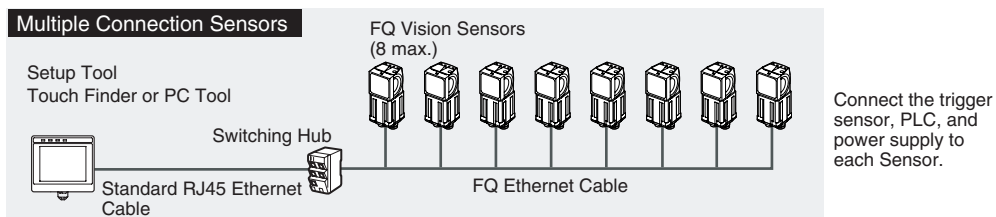
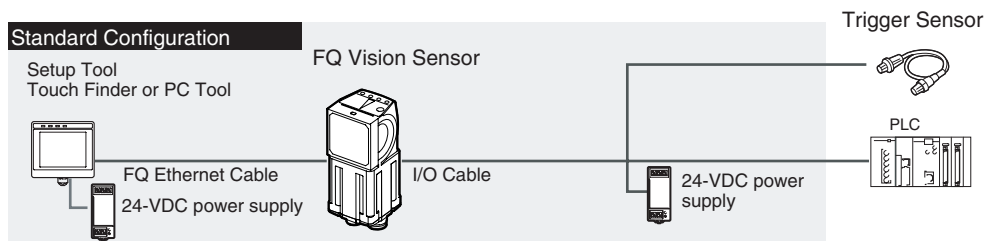

Product	Model number	Remarks
FQ Vision Sensor	FQ-S□□□□□□	This is the Vision Sensor.
Touch Finder	FQ-D□□	This is a setup console.
PC Tool	---	The PC Tool can be used instead of the Touch Finder. If you register as a member, you can download the free PC Tool as a special service to purchasers. Refer to the <i>Member Registration Sheet</i> that is enclosed with the Sensor for the member registration procedure and the download procedure for special member software.
FQ Ethernet Cable	FQ-WN0□□	Connects the Sensor to the Touch Finder or computer.
Standard RJ45 Ethernet Cable ^{*1}	---	Connects the switching hub to the Touch Finder or computer. Use a connector that complies with the FCC RJ45 standard. (STP (shielded twisted-pair) cable, category 5e or 6, impedance: 100 Ω)
I/O Cable	FQ-WD0□□	Connects the Sensor to the power supply and external devices.
Switching Hub	W4S1-0□□	Used to connect multiple Sensors to one Touch Finder or PC Tool.

*1: The shape and dimensions of the Ethernet connector plug and jack are specified in ISO/IEC8877:1992 (JIS X 5110:1996) and RJ-45 of the FCC regulations.
To prevent connector connection failures, the structure of the jack of this product does not allow insertion of plugs that do not comply with the standard.
If a commercially available plug cannot be inserted, it is likely that the plug is non-compliant.

Important

Do not connect network devices other than PLCs on the same network as the Touch Finder or computer. If another device is connected, the responsiveness of displays and settings of the Touch Finder or computer may become slow.

2-2 Installation

Installing the Sensor

Installation Procedure

- 1** Align the tabs on one side of the Mounting Bracket with the slot on the Sensor.
The FQ-XL Mounting Bracket can be attached to the back, side, or front of the Sensor.
- 2** Press the Mounting Bracket onto the Sensor until the other tabs click into place.
- 3** Use the following optical charts to check the field of view and installation distance of the Sensor so that it is mounted at the correct position.
Tightening torque (M4): 1.2 N·m

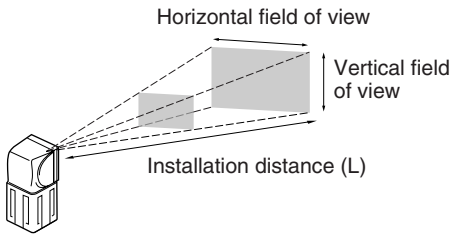
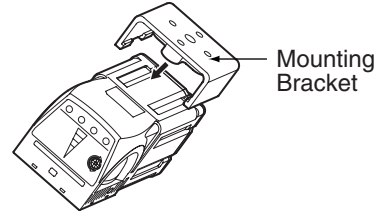

The optical chart indicates the horizontal field of view. The vertical field of view will be approximately 60% of the horizontal field of view.

Note: The tolerance is $\pm 10\%$.

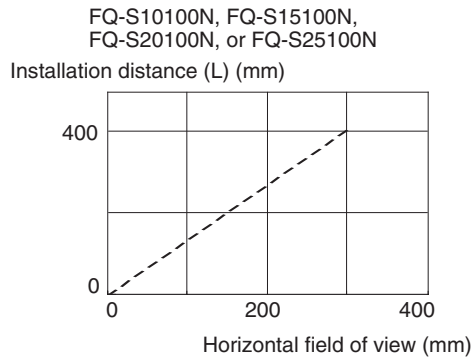
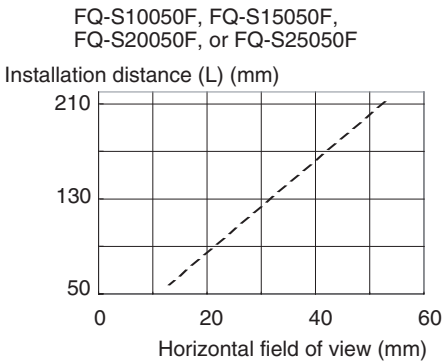
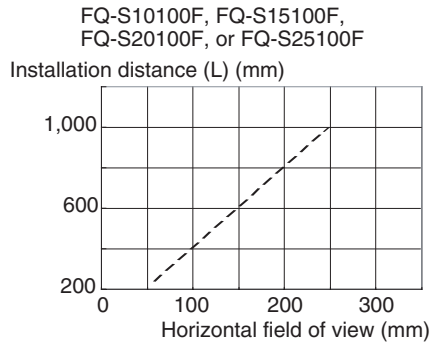
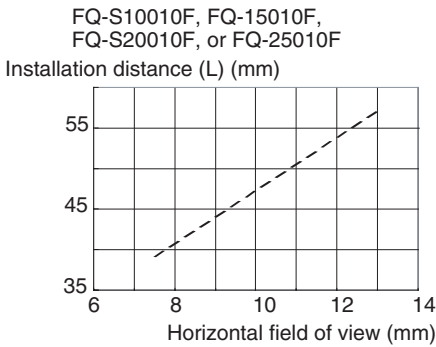

Important

- There is a certain amount of deviation among Sensors in the center of the optical axis. For this reason, when installing the Sensor, check the center of the image and the field of view on the LCD monitor of the Touch Finder and in the PC Tool.

Removal Procedure

- 1** Insert a flat-blade screwdriver between the Mounting Bracket and the Sensor case on either side and remove the Mounting Bracket.

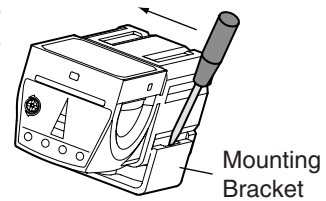

Installing the Touch Finder

Installation Precautions

Install the Touch Finder in the following orientation to allow sufficient heat dissipation.

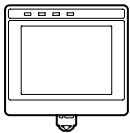

Do not mount it in the following orientations.

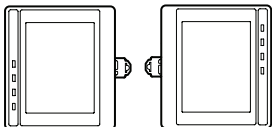

Important

- To improve ventilation, leave space on both sides of the Touch Finder. The distance between the Touch Finder and other devices should be at least that shown in the following diagram.

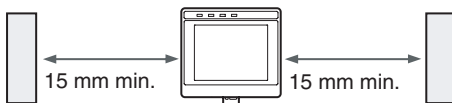

- Make sure that the ambient temperature is 50°C or lower. If it exceeds 50°C, install a cooling fan or an air conditioner and maintain the temperature at 50°C or lower.
- To prevent interference by noise, do not mount the Sensor on panels which contain high-voltage devices.
- To keep the level of noise from the surrounding environment to a minimum, install the Sensor and Touch Finder at least 10 m away from power lines.

Mounting to DIN Track

Installation Procedure

- 1** Press the slider on the Touch Finder to the top.
- 2** Hook the clip at the top of the Touch Finder on to the DIN Track.
- 3** Press the Touch Finder onto the DIN Track until the bottom clip clicks into place.

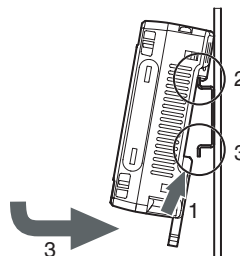

Important

- Attach End Plates (sold separately) on the sides of the Touch Finder on the DIN Track.
- If other devices will be installed next to the Touch Finder on the same DIN Track, make sure that sufficient space is kept between the devices as indicated on previous page.
- Always hook the clip at the top of the Touch Finder on the DIN Track first. If the lower clip is hooked on first, the Touch Finder will not be mounted very securely.

Removal Procedure

- 1** Pull down on the slider on the Touch Finder.
- 2** Lift the Touch Finder at the bottom and remove it from the DIN Track.

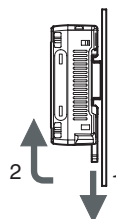

Mounting to a Control Panel

The Touch Finder can be mounted on a panel using the FQ-XPM Panel Mounting Adapter.

Important

- Always turn OFF the Touch Finder power before attaching or detaching the Panel Mount Adapter. Attaching or detaching with the power turned ON may cause a failure.

- 1** Set the Touch Finder in the Panel Mount Adapter.

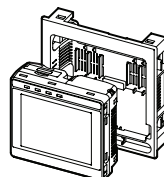

2 Press the slider up on the Touch Finder.

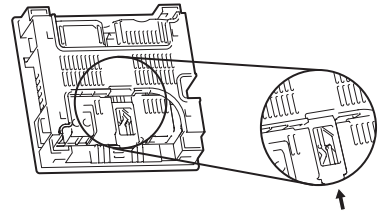

3 Create holes in the panel for mounting.

4 Connect the cable to the Touch Finder.

5 Mount the Touch Finder with the Panel Mount Adapter from the front of the panel.

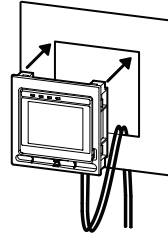

6 Hook the hooks on the Mounting Bracket in the four holes of the Panel Mount Adapter and secure them with screws. (Tightening torque: 1.2 N-m)

7 Check that the Touch Finder is attached properly to the Panel.

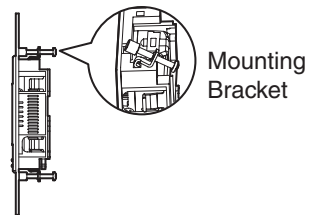

2-3 Wiring

Wiring the Sensor

Connect the I/O Cable to the I/O Cable connector located at the bottom of the Sensor.

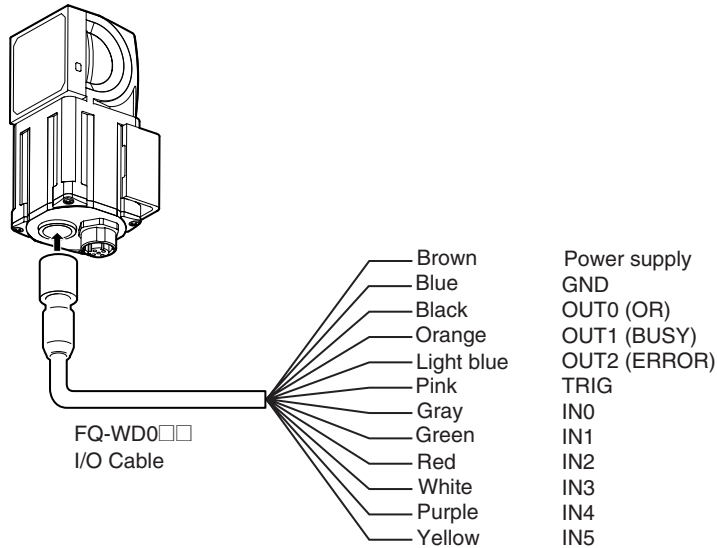

Important

Cut off lines that are not required so that they do not come into contact with the other signal lines.

Classification	Signal	Application
Power supply	Power supply (24 V)	These terminals are for the external power supply (24 V).
	GND	Important Wire the power supply separately from other devices. If the wiring for other devices is placed together or in the same duct as the wiring for the Vision Sensor, the influences of electromagnetic induction may cause the Sensor to malfunction or may damage it.
Inputs	TRIG	This terminal is the trigger signal input.
	IN0 to IN5	These are the command input terminals.
Outputs	OUT0 (OR)	By default, this is the OR output signal (overall judgement). The assignment can be changed to an individual judgement signal from OR0 to OR31.
	OUT1 (BUSY)	By default, this is the BUSY output signal. The assignment can be changed to an individual judgement signal from OR0 to OR31.
	OUT2 (ERROR)	By default, this is the ERROR output signal. The assignment can be changed to an individual judgement signal from OR0 to OR31.

I/O Signal Circuit Diagrams

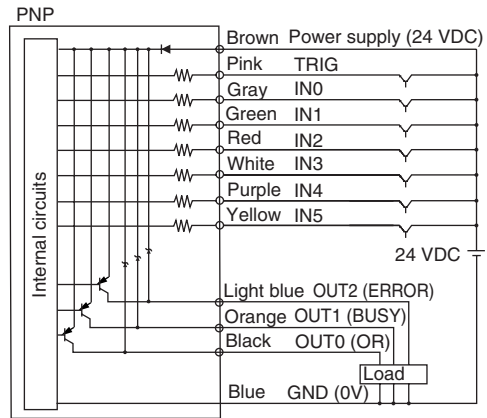
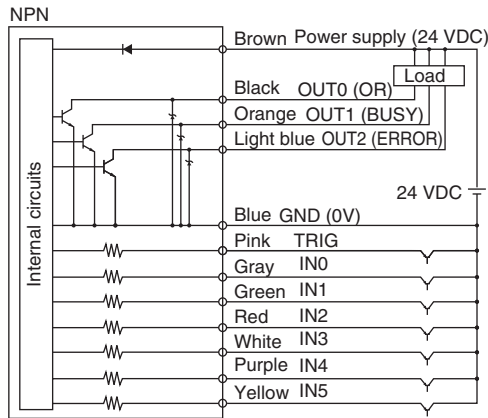

Important

Preventing Chattering

- The Sensor is equipped with an anti-chattering function, but if the chattering is 100 μ s or longer, a faulty input may occur. (Input signals of 99 μ s or shorter are ignored. Signals of 100 μ s or longer are treated as input signals.)
- Use no-contact output devices (e.g., SSR or PLC transistor output) for the input signals. If contacts (e.g., relay) are used, chattering may cause the trigger to be input again during execution of a measurement.

Power Supply Specifications When a Switching Regulator Is Connected

Use a power supply that meets the following specifications. (The power supply is sold separately.)

Item	Description
Power supply voltage	24 VDC (21.6 to 26.4 V)
Output current	3.75 A min.
Recommended Power Supply	S8VS-09024□ (24 VDC, 3.75 A)
External power supply terminal screws	M4 (tightening torque: 1.2 N·m)

Important

Supply power from a DC power supply for which measures have been applied to prevent high voltages (e.g., a safety extra low voltage circuit).

If UL certification is required for the overall system, use a UL Class II DC power supply.

Attaching the LED Warning Label

Attach the enclosed LED warning label to the cable or other location. The LED warning label must be attached to a location that is readily visible from the Sensor.

Attachment Example

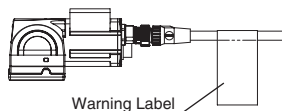

Warning Label

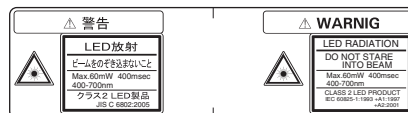

Wiring the Touch Finder

Power Supply Wiring

Connecting the Power Supply

- 1** Loosen the two terminal screws using a Phillips screwdriver.
- 2** Attach crimp terminals to the power lines. Secure the positive and negative lines as indicated using M3 screws.
Power supply tightening torque: 0.54 N·m
- 3** In environments where there is excessive noise, attach a ferrite core (ZCAT1730-0730 from TDK or the equivalent) to the power supply cable.

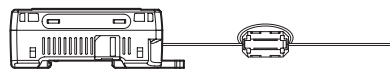
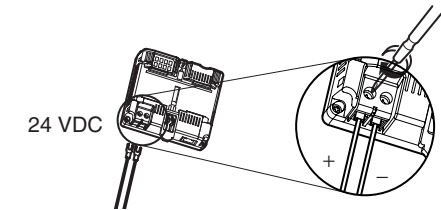

When you attach the ferrite core to the power supply cable, wrap the cable only one time.

Turning ON the Touch Finder

- 1** Remove the cover from the power switch on the left side of the Touch Finder.
- 2** Press the switch toward *ON*.

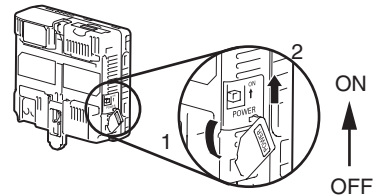

Power Supply Specifications

Use a power supply that meets the following specifications. (The power supply is sold separately.)

Item	Description
Power supply voltage	24 VDC (21.6 to 26.4 V)
Output current	2.5 A min.
Recommended Power Supply	S8VS-06024□ (24 VDC, 2.5 A)
External power supply terminal screws	M4 (tightening torque: 1.2 N·m)
Recommended power line wire size	AWG16 to AWG22 (length of 5 m max.)

Important

- Supply power from a DC power supply for which measures have been applied to prevent high voltages (e.g., a safety extra low voltage circuit).
If UL certification is required for the overall system, use a UL Class II DC power supply.
- When using the FQ-D31, do not connect a switching regulator and AC Adapter (FQ-AC□) at the same time.

Charging the Battery

This section describes how to charge and install the FQ-D31 Battery and provides applicable precautions.

Charge the Battery while it is attached to the Touch Finder.

Use the AC adapter to charge the battery.

Mounting the Battery in the Touch Finder

- 1** Remove the screw from the battery cover on the top of the Touch Finder, slide the cover in the direction of the arrow, and open the battery cover.

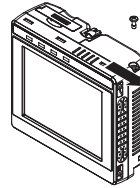

- 2** Face the rounded side of the battery toward the back of the Touch Finder and insert the battery.

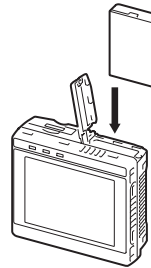

Important

Do not insert the battery in the wrong orientation.

- 3** Close the battery cover, slide the battery cover in the direction of the arrow, and tighten the screw on the battery cover.

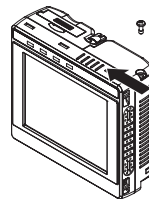

- 4** Attach the AC adapter to the Touch Finder to start charging the battery.

The CHARGE indicator will be lit while the battery is being charged. It will go out when charging the battery has been completed.

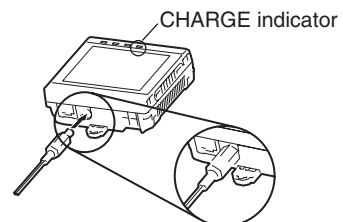

Note

The Touch Finder will operate even if the AC adapter is connected when no battery is mounted in the Touch Finder.

Important

- If the Touch Finder (FQ-D31) will be installed permanently or semi-permanently, remove the Battery (FQ-BAT1). If the rated temperature is exceeded with the Battery inserted, the protective circuit may activate and stop the Touch Finder.
- The battery complies with the following recycling regulation.

Japan



Li-ion00

EU



Taiwan



- California regulations concerning perchlorate:

This product is a lithium battery that contains perchlorate, which is regulated by the State of California. Please comply with these regulations. For details see the following URL:

www.dtsc.ca.gov/hazardouswaste/perchlorate/

2-4 Setting Up Ethernet

Connecting to Sensors from the Touch Finder

When the Sensor is used with a Touch Finder, IP addresses are automatically assigned. No settings are required to use Ethernet.

However, if a Sensor or Touch Finder is connected to a network where a PLC or computer is already connected, the Ethernet must be set to be compatible with the existing network.

- Touch Finder

▶  (Setup Mode) – [TF settings] – [Ethernet]

1 Set the IP address and subnet mask according to the network settings.

Connecting to Sensors from a Computer Using the PC Tool

When connecting the Sensor directly to a computer using an Ethernet Cable, set the network settings on the computer as given below. Setting a fixed IP address is not required if there is a hub between the computer and Sensor and a DHCP server is used.

The following procedure is for Windows XP.

1 Select [Control Panel] from the Windows Start Menu.

2 Click [Network and Internet Connections] in the control panel and then double-click [Network Connections].

3 Right-click the [Local Area Connection] icon and select [Properties].

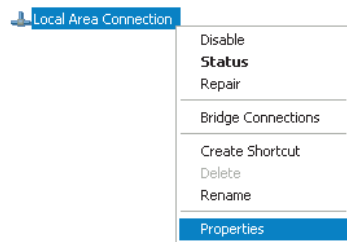

- 4** On the [General] Tab Page, double-click *Internet Protocol (TCP/IC)*.

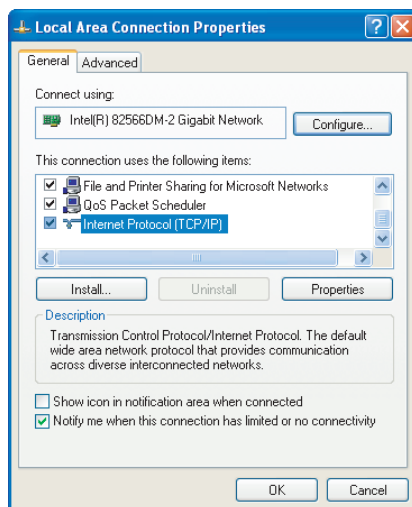

- 5** Select the *Use the following IP address* Option and enter the following IP address and subnet mask.

- IP address: 10.5.5.101
- Subnet mask: 255.255.255.0

- 6** Click the [OK] Button. This completes the settings.

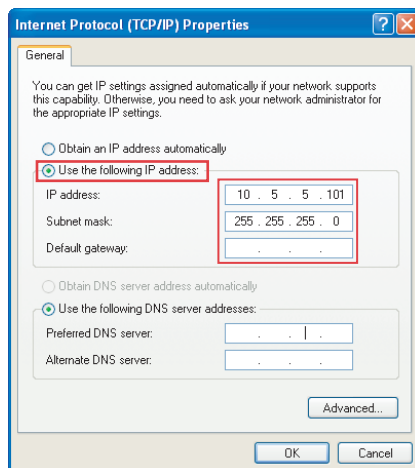

MEMO

Taking Images

3-1 Selecting a Sensor for Configuration.....	24
3-2 Adjusting Image Quality	25
3-3 Adjusting the Object Position.....	30

3-1 Selecting a Sensor for Configuration

If multiple Sensors are connected to a single Touch Finder or computer, you can select the Sensor that you want to set up.

- 1 Press [Run].**
This will enable setting the current Sensor into RUN Mode before selecting another Sensor.
- 2 Then press [Switch to Run mode].**

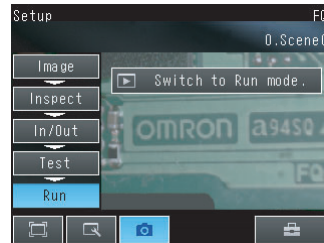

- 3 Press [Yes].**

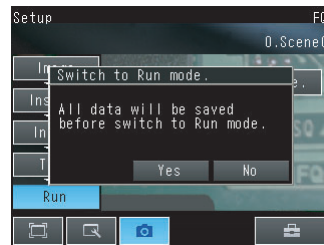

- 4 Press [Switch Sensor].**
- 5 Press the image of the Sensor to be set up.**
⚠ will be displayed for Sensors that are not yet set.

Note

Once the Touch Finder detects and records a Sensor, the display order for showing more than one Sensor is fixed. Even if the system configuration is changed to reduce the number of Sensors, the previous display location will remain for Sensors that were removed. To update displays of multiple Sensors to the current connection status, press [◀] - [Auto connect] on the right of the display in step 5, above, to automatically reconnect.

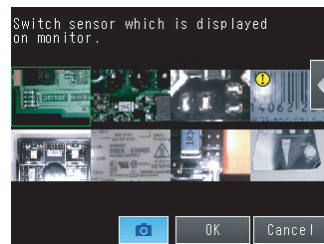

- 6 Press [Sensor settings] to return to Setup Mode.**

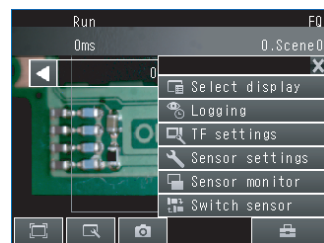

- 7 Press [Yes].**

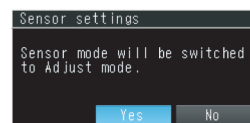

3-2 Adjusting Image Quality

Adjusting the Focus

► [Image] – [Camera setup]

1 Display the Camera Setup Display.

The focus can be seen as a numerical value. The higher the value, the better the focus.



Focus Level

2 Manually adjust the focus using the focus adjustment screw on the Sensor while checking the image and focus value on the Touch Finder.

In the default settings, the field of view is set to the narrowest setting.

3 Press [Back].

Focus adjustment screw

Turn clockwise to focus on closer objects.
(The field of view will narrow.)



Turn the screw counterclockwise to focus on objects at a distance.
(The field of view will widen.)

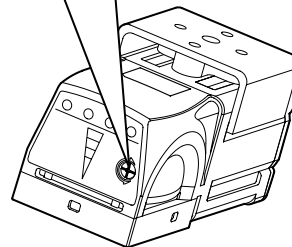

Important

- Turn the focus adjustment screw clockwise or counterclockwise a little bit to make sure that it has not already reached the dead stop. Do not force the screw if it does not rotate anymore. This will damage the Sensor.
- Do not turn the focus adjustment knob with a force that is greater than 0.1 N·m. This may damage it.

Adjusting the Brightness

To achieve stable measurements, the brightness of the camera image must be adjusted so that the characteristic to be measured is clearly visible.

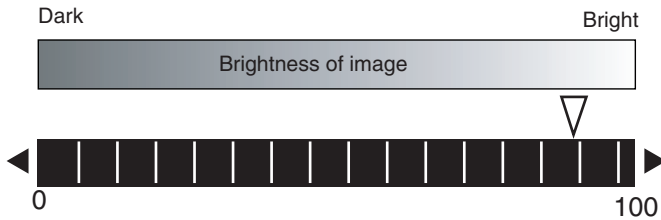

► [Image] – [Camera setup]

- 1 Press [**◀**] - [Brightness] on the right side of the display.
- 2 Move the bar to the left or right to adjust the brightness.
Moving it to the right will make the image brighter, while moving it to the left will reduce the brightness of the image.
Press [AUTO] to automatically adjust the brightness according to the image.

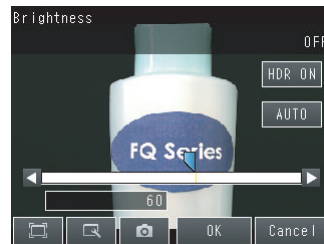

- 3 Press [OK].

Important

The exposure time will be longer for larger values. This may cause the image to blur if the object is moving fast. If the Sensor is used on a high-speed line, check that the images are not blurred under actual operating conditions.

Taking Clear Images of Moving Objects

For quick moving objects, the effect of blurring can be reduced by decreasing the exposure time.

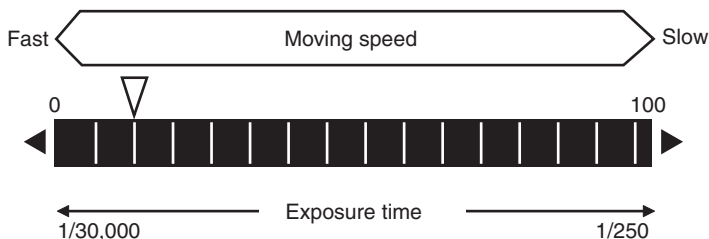

► [Image] – [Camera setup] – [**◀**] – [Brightness]

📖 Adjusting the Brightness: p. 26

Important

The image becomes darker the smaller the exposure time. If the Sensor is used in a dark environment, make sure that the darkness of the image does not cause the measurements to be unstable.

Improving the Image Quality of Metallic and other Shiny Surfaces

When objects with shiny surfaces are being measured, the lighting may be reflected off the surface and affect the image.

To remove reflections, one of the following two functions can be used.

Function	Description
HDR (High Dynamic Range)	If objects have contrasting light and dark areas, the dynamic range can be made wider to improve the quality of the images.
Polarizing filter	Specular reflections can be eliminated from an image by attaching a polarizing filter to the Sensor.

• Selection Tips

• When the measurement object is not moving	→ Use the HDR function.
• When the measurement object is moving	→ Use a polarizing filter.

HDR Function

The HDR function is used for objects that have a large difference between light and dark areas. For this kind of object, clear images cannot be achieved with the standard brightness setting. The HDR function combines several images of different brightnesses (exposure times) so that the resulting image has a lower degree of contrast and can be measured stably for the desired characteristic.

Inputting Images with a Limit Range of Brightness

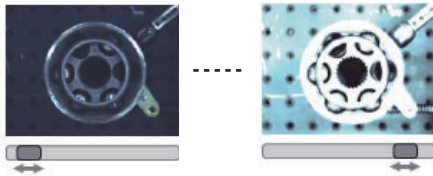

Combining Images to Create an Image with a Wide Dynamic Range

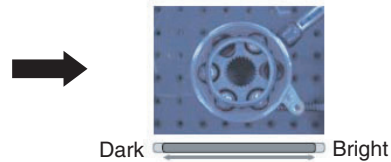

Observe the following precautions.

- Use the HDR function only for objects that are not moving to avoid image blurring.
Several images are taken with different shutter speeds and combined. If the object moves while the image is being taken, the image will become blurred.
- Images with different brightnesses are combined, so the resulting image will have a lower degree of contrast.

► **[Image] – [Camera setup]**

1 Press [**◀**] – [**Brightness**] on the right side of the display.

2 Press the [**HDR ON**] Button.

The best HDR mode will be selected automatically.

The enabled range will appear in blue on the brightness adjustment bar.

3 Press the [**OK**] Button.



Note

- If the measurement object is changed after setting the HDR function, press the [**AUTO**] Button to automatically set the HDR mode again.
- If the automatic selection does not achieve the desired results, press the [**HDR**] Button and manually set the best HDR mode. As shown below, the higher the level, the wider the combined dynamic range will be.

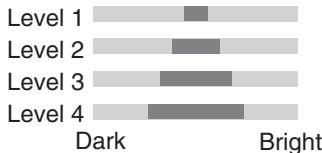

- If the reflections cannot be sufficiently removed using the HDR function, use a polarizing filter as well.

Using a Polarizing Filter

Specular reflections can be eliminated from an image by attaching a FQ-XF1 Polarizing Filter to the Sensor.

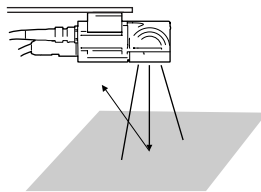

Observe the following precautions.

- The image will be darker compared to when no filter is used.
- If the image becomes too dark, adjust the brightness.

📖 p. 26

• **Mounting the Filter**

1 Hook the filter in the hole at the top of the Sensor.

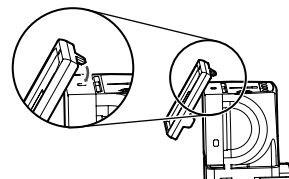

- Using the top section as a pivot point, pull down the filter so that it attaches to the Sensor.

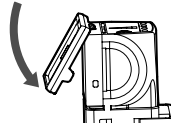

Adjusting the Colors of the Image (White Balance)

If external lighting is used, the image may appear as having different colors than the actual object. If this is the case, adjust the white balance.

If the lighting built in to the Sensor is used, the white balance is already adjusted. No setting is required in this case.

► [Image] – [Camera setup]

- Input a picture of white paper or cloth.
- Press [◀] – [White balance] on the right side of the display.
- Press the [Auto] Button. The Sensor will automatically adjust the colors.
- Move the bar to the left (light) or right (dark) to fine-tune the colors.
- Press [OK].

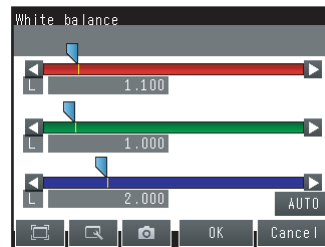

3-3 Adjusting the Object Position

If objects are moving, the position in the image of the characteristic that is to be measured will vary according to the timing of the trigger signal. The FQ Vision Sensor offers two different ways to adjust this position variation.

Function	Description	Reference
Position compensation	If the timing of the trigger is accurate, the FQ Vision Sensor can correct variations in the position of the object for each measurement with the Position Compensation function.	p. 30
Trigger delay	A delay can be applied from when the trigger (the TRIG signal) is input until when the image is input, to synchronize the timing of image input with the speed of the moving objects.	p. 32

Position Compensation

The FQ Vision Sensor performs measurements in measurement regions that are set to a fixed shape and position by the operator. A measurement is not performed properly if the object is not positioned inside this measurement region (e.g., the result will be NG even if the object is OK). In machines in which the position of the object varies for each image, stable measurements would be impossible. To cope this problem, the Position Compensation function aligns the whole image so that the object to be measured is moved exactly to the measurement region.

- Reference position (as set by the operator)
The measurement object is properly within the measurement region.

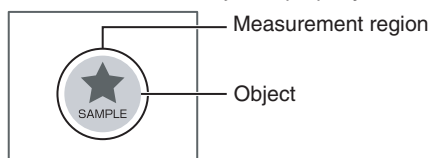

- Object is out of place:
The measurement object is outside the measurement region.

The image is aligned so that the object is returned to the reference position before performing measurements.

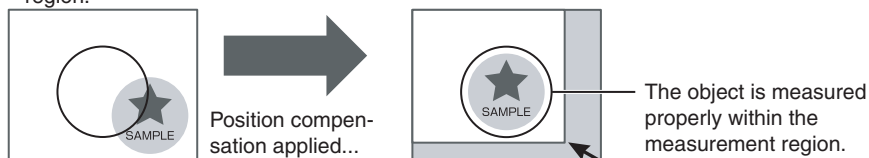

► [Image] – [Position compensation] – [Mode on/off]

- 1 Press [ON] for [Mode on/off]
- 2 Press [Settings].

- 3** Press [Teach].
- 4** Adjust the image so that the measurement object is in the center.
- 5** Press [◀] – [Model region].
- 6** Move the rectangle so that the characteristic part for position compensation is inside it.
- 7** Press [OK].
- 8** Press [Teach].
The characteristic part and reference position for position compensation will be registered.
- 9** Press [OK] to save the settings.

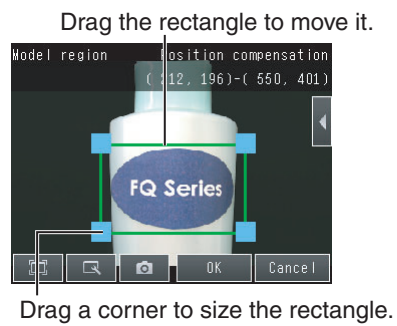

Adjusting the Image Timing

The internal timing for taking an image can be set to be delayed in relation to the external trigger signal. This can be used to adjust the object position in the image, e.g., if an external trigger sensor is used. If the object position still varies in the image the Position Compensation function must also be used.

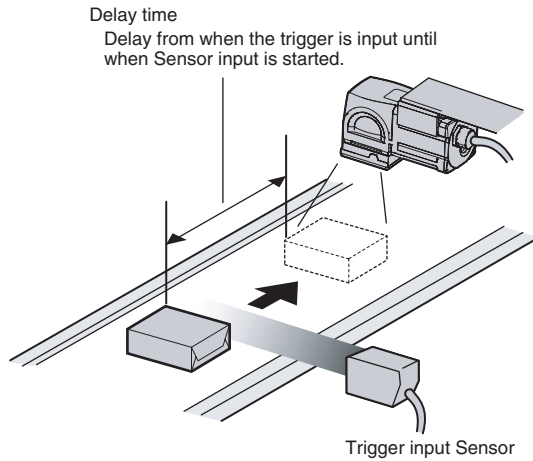

► [Image] – [Trigger setup] – [Trigger delay]

- 1 A TRIG signal is input.**
Images are input continuously.
- 2 Select the image with the measurement object in the center using [◀] and [▶].**
- 3 Press the image.**
- 4 Press [OK].**

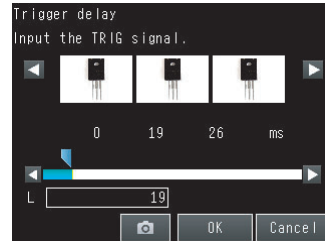

Note

The delay time can be set using the adjustment bar or by directly entering a value.

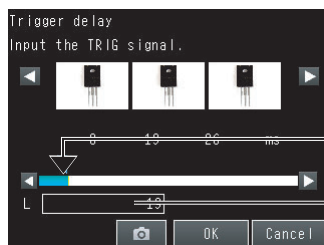







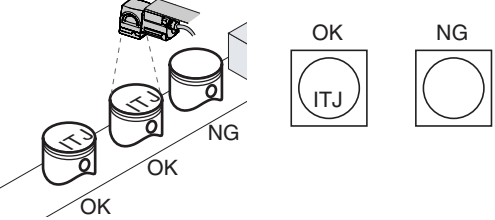

Setting Up Inspections

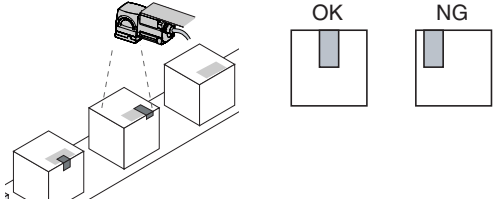
4-1 Inspection Item Selection Guide	34
4-2 Setup Procedure for Inspection Items	35
4-3 Inspecting with the Search Inspection Item	36
4-4 Inspecting with the Edge Position Inspection Item	38
4-5 Inspecting with the Edge Width Inspection Item	40
4-6 Inspecting with the Area Inspection Item	42
4-7 Inspecting with Color Data Inspection Item	44

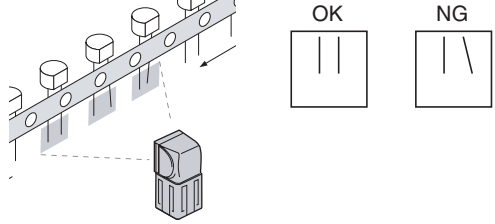
4-1 Inspection Item Selection Guide

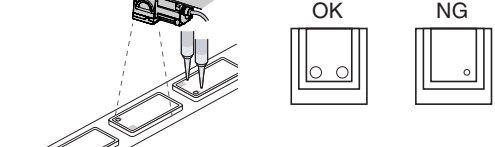
The FQ Vision Sensor uses inspection items to judge measurement objects. There are five different measurement objects. Select the best inspection items for the characteristics of the measurement object that are being judged.

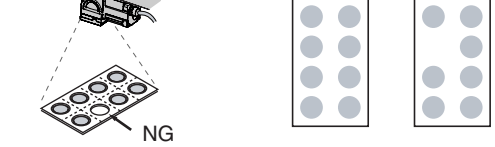
Inspection	Example	Inspection items used	Reference
Judging according to shapes 	Judging if there is a mark 	Search	p. 36
Judging according to positions 	Measuring the position offset of a seal 	Edge Position	p. 38
Judging according to widths 	Measuring the width between lead wires 	Edge Width	p. 40
Judging according to sizes 	Judging if there is silver paste 	Area	p. 42
Judging according to colors 	Detecting parts 	Color Data	p. 44

4-2 Setup Procedure for Inspection Items

The basic steps for setting up inspection items are shown below.

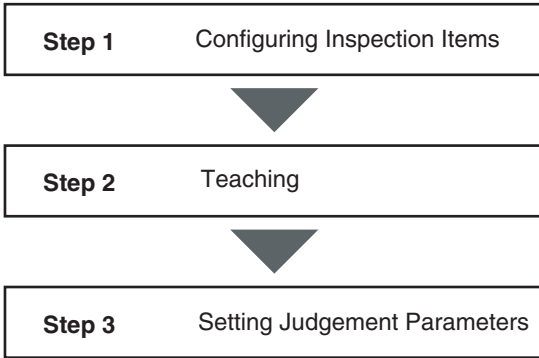

If measurements are unstable

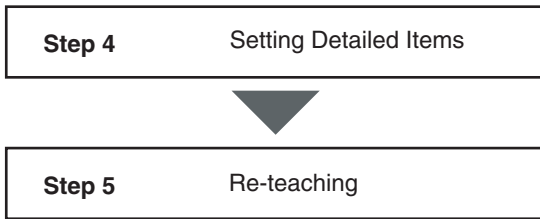

Note

- Only one inspection item can be used with a single-function model (FQ-S1 Sensors).
- Up to 32 inspection items can be combined and used with a standard model (FQ-S2 Sensors).

4-3 Inspecting with the Search Inspection Item

Search Inspection Item

This inspection item is used to perform inspections for shapes or for presence. The image pattern that is to be measured is registered in advance and measurements are performed to see if the pattern is present or if the shape is different.

The image pattern that is registered in advance is called the model. The degree to which the image matches the model is called the correlation.

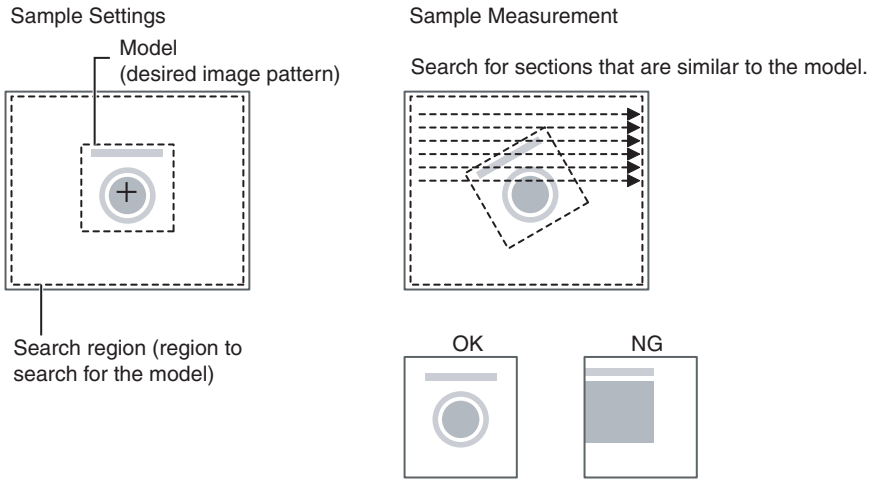

Setup Procedure for the Search Inspection Item

Step 1 Selecting the Inspection Item

► [Inspect]

- 1 Press an unused inspection item number and press [Add item.].
- 2 Press [Search].

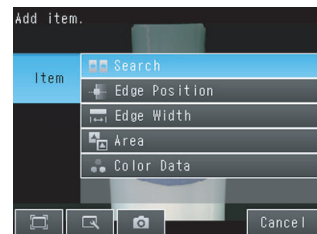

Step 2 Teaching

Teaching means to store the region and partial image as reference data for the measurement.

► [Inspect] – [Add item.] – [Search] – [Settings] Tab Page

- 1 Press [Teach].
- 2 Place the object that is to be used as the measurement reference in front of the camera.
- 3 Move the rectangle to the location to be measured.
- 4 Press [OK].
- 5 Press [TEACH] on the lower right of the display.
The basic settings will be registered when teaching has been completed.
- 6 Press [Back] to end teaching.

Drag the rectangle to move it. Drag a corner to size the rectangle.

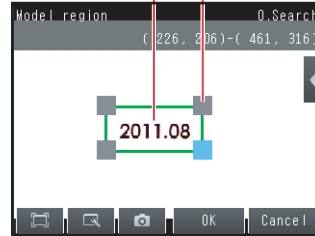

The following data is stored as the measurement reference.

Item	Parameter	Description
Reference data	Model image	This is the partial image that is stored as the reference.
	Reference position X	These are coordinates of the model image that are stored as reference.
	Reference position Y	

Step 3 Adjusting Judgement Parameters

► [Inspect] – [Add item.] – [Search] – [Settings] Tab Page

- 1 Press [Judgement].
- 2 Set the correlation range for an OK judgement.
Continuous measurements will be performed for the images that are taken.
- 3 Press [OK] to accept the value.
- 4 Press [Back] to end making the setting.

Lower limit Upper limit

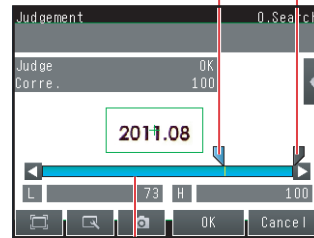

Blue for OK. Red for NG.

Parameter	Setting	Description
Correlation	Range: 0 to 100 Default: Lower limit: 60, Upper limit: 100	Adjust the upper and lower limits of the correlation for an OK judgement.

4-4 Inspecting with the Edge Position Inspection Item

Edge Position

This inspection item is used to inspect positions. For example, it can be used to see if a label is attached at the correct position or if a product is set in the correct position.

Places where the color changes greatly are called edges. The positions of these edges are measured.

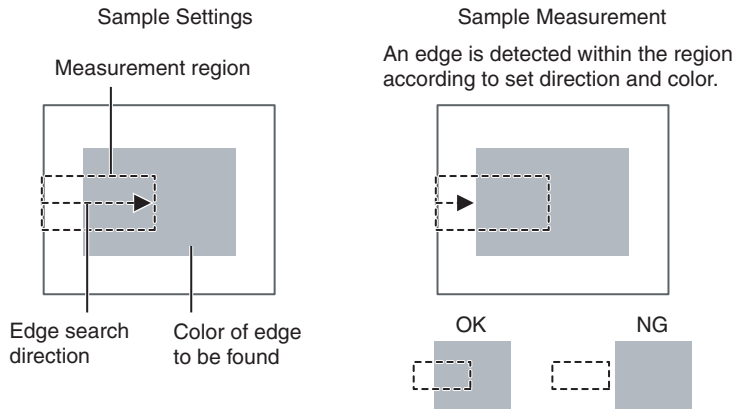

Setup Procedure for Edge Position

Step 1 Selecting the Inspection Item

► [Inspect]

- 1 Press an unused inspection item number and press [Add item].
- 2 Press [Edge position].

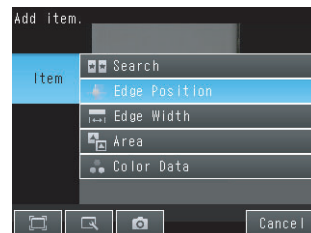

Step 2 Teaching

Teaching means to store the region and the edge position in the region as reference data for the measurement.

► [Inspect] – [Add item.] – [Edge Position] – [Settings] Tab Page

- 1 Press [Teach].
- 2 Place the object that is to be used as the measurement reference in front of the camera.
- 3 Move the rectangle to the location to be measured.
- 4 Press [OK].
- 5 Press [TEACH] on the lower right of the display.
The basic settings will be registered when teaching has been completed.
- 6 Press [Back] to end teaching.

The arrow in the middle shows the direction for detecting an edge.

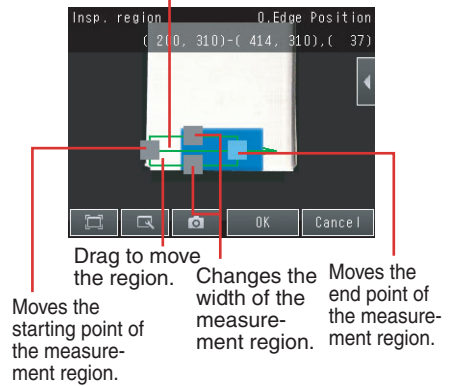

The following data is stored as basic measurement data.

Item	Parameter	Description
Reference data	Reference position X	The reference coordinates (X, Y) of the position are set automatically.
	Reference position Y	

Step 3 Adjusting Judgement Parameters

► [Inspect] – [Add item.] – [Edge Position] – [Settings] Tab Page

- 1 Press [Judgement].
- 2 Set the range within which the D. Position is judged as OK.
Continuous measurements will be performed for the images that are displayed.
- 3 Press [OK] to enter the value.

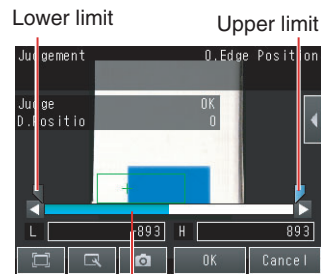

Item	Parameter	Setting	Description
Judgement Parameter	D. Position	Range: -893 to 893 Default: Lower limit: -893, Upper limit: 893	Set the upper and lower limits from the reference position as the offset within which the judgement will be OK.

4-5 Inspecting with the Edge Width Inspection Item

Edge Width Inspection Item

This inspection item is used to measure dimensions. Places where the color changes greatly are called edges. The distance between two edges is called the edge width.

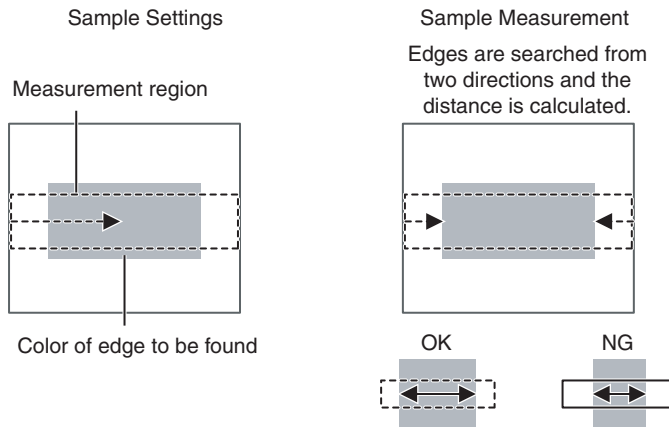

Setup Procedure for Edge Width Inspection Item

Step 1 Selecting the Inspection Item

► [Inspect]

- 1 Press an unused inspection item number and press [Add item.].
- 2 Press [Edge Width].

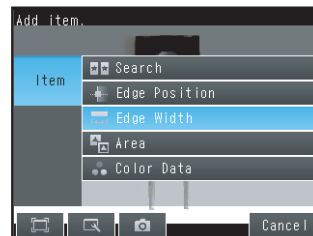

Step 2 Teaching

Teaching means to store the region and the edge width in the region as reference data for the measurement.

► [Inspect] – [Add item.] – [Edge Width] – [Settings] Tab Page

- 1 Press [Teach].
- 2 Place the object that is to be used as the measurement reference in front of the camera.
- 3 Move the rectangle to the location to be measured.
- 4 Press [OK].
- 5 Press [TEACH] on the lower right of the display.
The basic settings will be registered when teaching has been completed.
- 6 Press [Back] to end teaching.

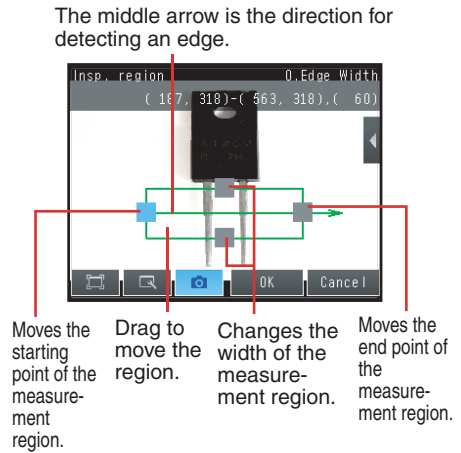

The following data is stored as the measurement reference.

Item	Parameter	Description
Reference data	Reference width	The reference edge width is set automatically.

Step 3 Adjusting the Judgement Parameters

► [Inspect] – [Add item.] – [Edge Width] – [Settings] Tab Page

- 1 Press [Judgement].
- 2 Set the D. Width range for an OK judgement.
Continuous measurements will be performed for the images that are displayed.
- 3 Press [OK] to enter the value.

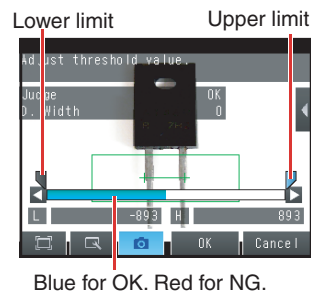

Item	Parameter	Setting	Description
Judgement Parameter	D. Width	Range: -893 to 893 Default: Lower limit: -893, Upper limit: 893	Set the upper and lower limits of the reference width for an OK judgement.

4-6 Inspecting with the Area Inspection Item

Area Inspection Item

This inspection item is used to measure sizes. It measures the amount of a color within the measurement region. The size is calculated as a number of pixels and it is called the area.

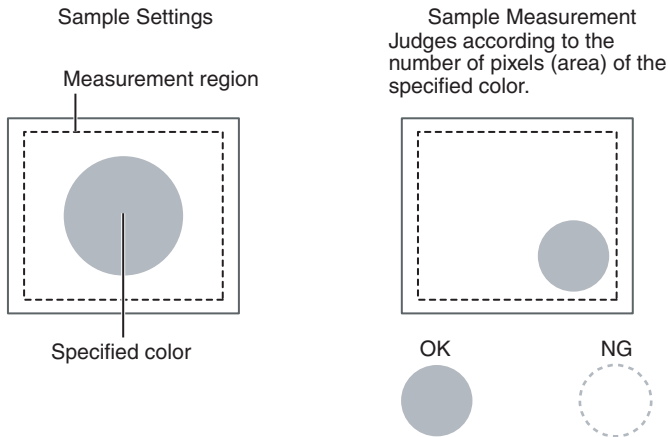

Setup Procedure for Area

Step 1 Selecting the Inspection Item

► [Inspect]

- 1 Press an unused inspection item number and press [Add item].
- 2 Press [Area].

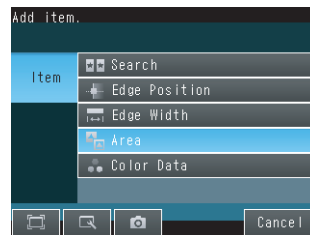

Step 2 Teaching

Teaching means to store the region and the color area in the region as reference data for the measurement.

► [Inspect] – [Add item.] – [Area] – [Settings] Tab Page

- 1 Press [Teach].
- 2 Place the object that is to be used as the measurement reference in front of the camera.
- 3 Move the rectangle to the location to be measured.
- 4 Press [OK].
- 5 Press [TEACH] on the lower right of the display.
The basic settings will be registered when teaching has been completed.
- 6 Press [Back] to end teaching.

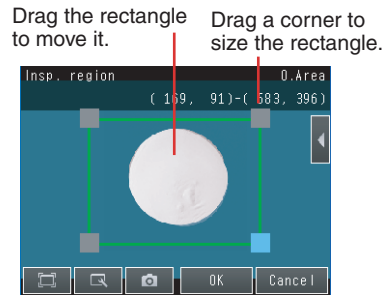

The following data is stored as the measurement reference.

Item	Parameter	Description
Reference data	Extract color	This is the color for which to measure the area. The color occupying the largest area will be automatically registered.
	Reference area	The area to use as a reference is set automatically.

Step 3 Adjusting Judgement Parameters

► [Inspect] – [Add item.] – [Area] – [Settings] Tab Page

- 1 Press [Judgement].
- 2 Set the D. Area range for an OK judgement.
Continuous measurements will be performed for the images that are displayed.
- 3 Press [OK] to enter the value.

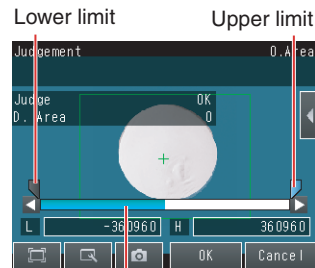

Blue for OK. Red for NG.

Item	Parameter	Setting	Description
Judgement Parameter	D. Area	Range: -360,960 to 360,960 Default: Lower limit: -360,960, Upper limit: 360,960	Set the upper and lower limits for an OK judgement. The set range is the difference between the reference area and the measured areas.

4-7 Inspecting with Color Data Inspection Item

Color Data Inspection Item

This inspection item is used to perform inspections for foreign matter with a different color or for presence. The region is set for a portion of the image with the color that is to be measured. This region is called the measurement region. The average color within the measurement region is measured.



Setup Procedure for Color Data Inspection Item

Step 1 Selecting the Inspection Item

► [Inspect]

- 1 Press an unused inspection item number and press [Add item.].
- 2 Press [Color Data].

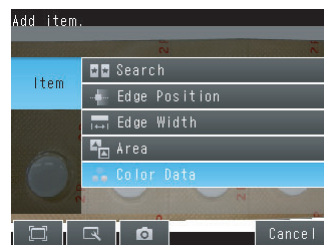

Step 2 Teaching

Teaching means to store the region and the average color in the region as reference data for the measurement.

► [Inspect] – [Add item.] – [Color Data] – [Settings] Tab Page

- 1 Press [Teach].
- 2 Place the object that is to be used as the measurement reference in front of the camera.
- 3 Move the rectangle to the location to be measured.
- 4 Press [OK].
- 5 Press [TEACH] on the lower right of the display.
The basic settings will be registered when teaching has been completed.
- 6 Press [Back] to end teaching.

Drag the rectangle to move it.
Drag a corner to size the rectangle.

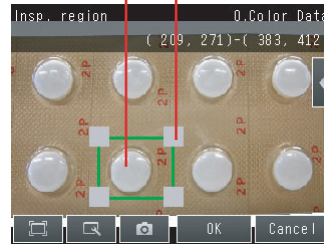

The following data is stored as the measurement reference.

Item	Parameter	Description
Reference data	Hue	The hue to use as a reference is set automatically.
	Saturation	The saturation to use as a reference is set automatically.
	Brightness	The brightness to use as a reference is set automatically.

Step 3 Adjusting Judgement Parameters

► [Inspect] – [Add item.] – [Color Data] – [Settings] Tab Page

- 1 Press [Judgement].
- 2 Set the range of color differences that are to be judged as OK.
Continuous measurements will be performed for the images that are displayed.
- 3 Press [OK] to enter the value.

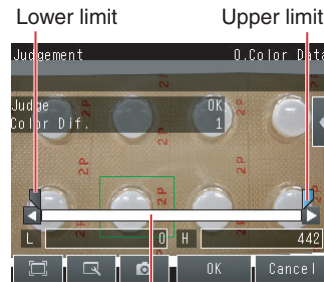

Blue for OK. Red for NG.

Item	Parameter	Setting	Description
Judgement Parameter	Color Dif.	Range: 0 to 442 Default: Lower limit: 0, Upper limit: 442	Sets the upper and lower limits of the difference between the average color and reference color that is to be judged as OK.

MEMO

Testing and Saving Settings

5-1 Performing Test Measurements.....	48
5-2 Adjusting the Judgement Parameters.....	49
5-3 Checking a List of All Inspection Item Results	51
5-4 Saving Data to the Sensor.....	52

5-1 Performing Test Measurements

After completing the settings in the [Image], [Inspect], and [In/Out] Tab Pages, move to the [Test] Tab Page. The displayed image is measured automatically. This is called a test measurement. A test measurement is used to verify that the settings that have been made will produce stable results and, if necessary, to fine-tune the settings. An overall judgement of all inspection items can be performed. Test measurements can be performed for through images (default) or saved images.

Performing Test Measurements with Samples

► [Test] – [Continuous test]

- 1** Press [Graphics+Details].
- 2** Input an image of a previously prepared object. Check the judgement results.
- 3** When you finish checking the results, press [Back].



Note

The same five types of displays are available for the [Continuous test] on the [Test] Tab Page, i.e., [Graphic], [Graphics + Details], [All results/region], [Trend monitor], and [Histogram]. Press the [Back] Button to access the menu to change the display.

 Changing the Run Mode display: p. 56

5-2 Adjusting the Judgement Parameters

Adjusting Judgement Parameters While Looking at Measurement Results

If correct judgements are not possible, you can move directly from the Setup Mode display to the judgement parameters display to make adjustments.

► [Test] – [Continuous test] – (Either display)

- 1 Press [◀] – [Adjust judgement] on the right of the display.
- 2 Adjust the judgement parameters.

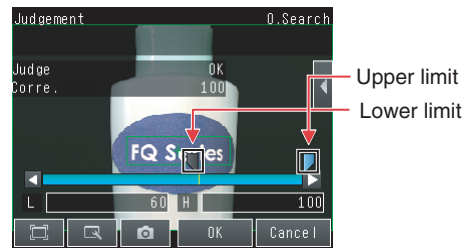

Setting Up the Best Judgement Parameters Automatically

The judgement parameters of the selected inspection items can be automatically adjusted by using actual workpieces which are considered as good and faulty products.

► [Test] – [Continuous test]

- 1 Move to the inspection item for which you want to automatically adjust the judgement parameters and press [◀] – [Adjust judgement] on the right side of the display.
- 2 Press [◀] – [Auto adjustment].
- 3 Display a sample image of a good object and press [OK Teach]. Display a sample image of a bad object and press [NG Teach].

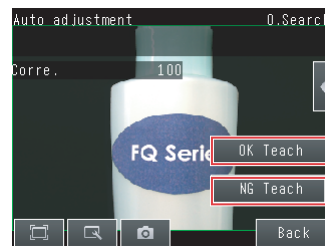

- 4 Repeat these steps for at least two samples each.
- 5 Press [Back].
The best judgement parameters will be set automatically.
- 6 Press [OK].

Note

You can select one of the following three patterns as the judgement method.

► [◀] – [Select the method.] on the right side of the display

- 1) Threshold (minimum): The lower limit of the variations between OK object is used as the judgement condition.
- 2) Threshold (average): The median value between the OK object variations and NG object variations is used as the judgement condition.
- 3) Threshold (maximum): The upper limit of the variations between NG object is used as the judgement condition.

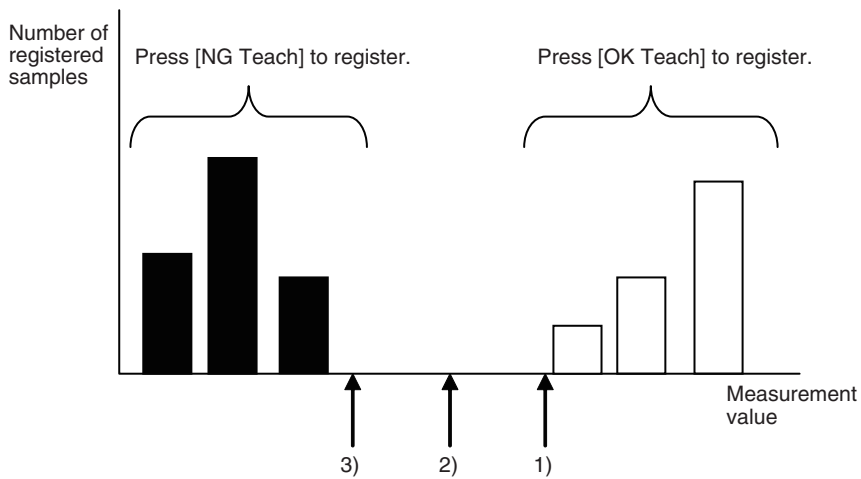

5-3 Checking a List of All Inspection Item Results

Individual judgement results for all inspection items can be checked in a list. The individual inspection items can be selected to change the judgement parameters.

► [Test] – [Continuous test]

1 Press [All results/region] to display the list.

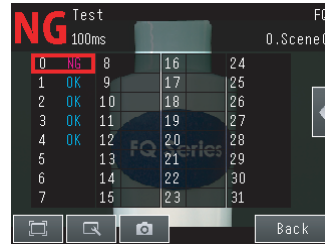

Note

Judgement parameters can also be changed from this display. Select an inspection item and press [◀] – [Adjust judgement].

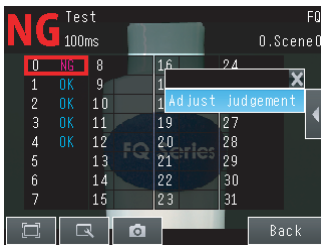

5-4 Saving Data to the Sensor

Until you have saved your settings explicitly to the memory in the FQ Vision Sensor, the settings are only stored temporarily. They will be lost if the power is turned OFF. Execute [Save data] after you have finished making your settings. The FQ Vision Sensor will remind you to do so with a message if you switch from Setup Mode to Run Mode. You can use this feature to keep the previous settings and discard the new settings if desired, but keep in mind that all settings that are not saved explicitly are replaced by the settings that are stored in the memory of the FQ Vision Sensor the next time you turn ON the FQ Vision Sensor.

Important

Do not turn the power supply OFF while data is being saved. The data that is being saved may become corrupted.

► [Test]

- 1 Press [Save data].
- 2 Press [Yes].

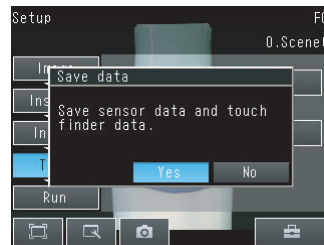

Note

- Scene data and system data can be saved in this way.

Operation

6-1 Starting Operation	54
6-2 Configuring the Run Mode Display	56
6-3 Adjusting Judgement Parameters during Operation	58

6-1 Starting Operation

When test measurements and adjustments in Setup Mode have been finished, the display moves to Run Mode and actual measurements begin. In Run Mode, the Sensor operates stand-alone and outputs the measurement judgement results on the I/O lines accordingly to the settings. If the Touch Finder or the PC Tool is connected via network to the Sensor, the operation of the Sensor can be monitored in the following ways.

Run Mode Display

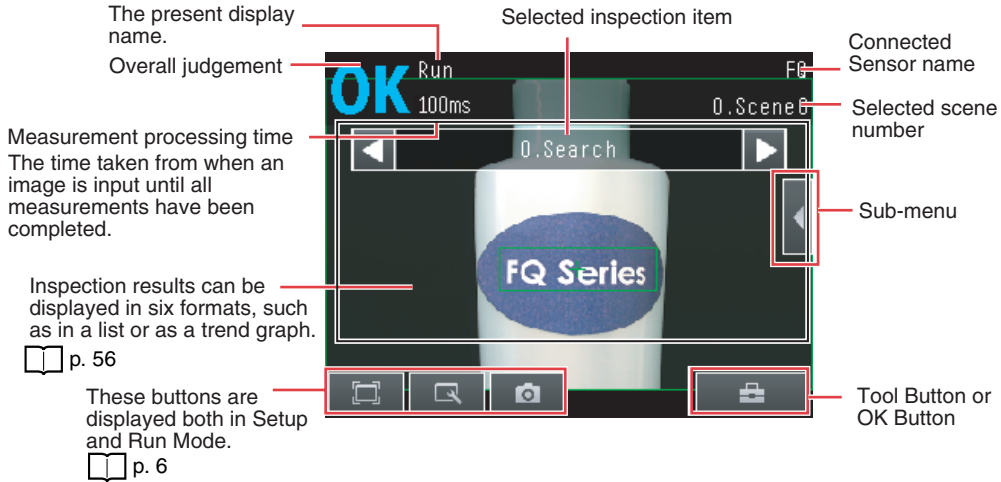

Moving to Run Mode

You can move from Setup Mode to Run Mode by using the following procedure.

- 1 Press [Run].**
- 2 Press [Switch to Run mode.].**
- 3 Press [Yes].**
If you press [No], the setting will not be saved and you will move to Run Mode.

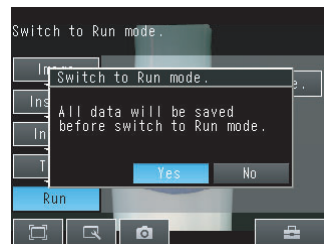
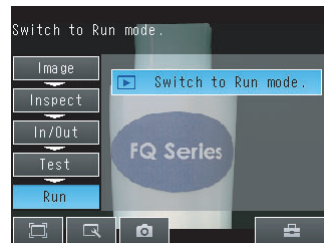

Note

- Returning to Setup Mode

Press  and press [Sensor settings].

- Signal Status When Moving to Run Mode

When moving to Run Mode, the signal will change as shown below and data can be input from and output to an external device.

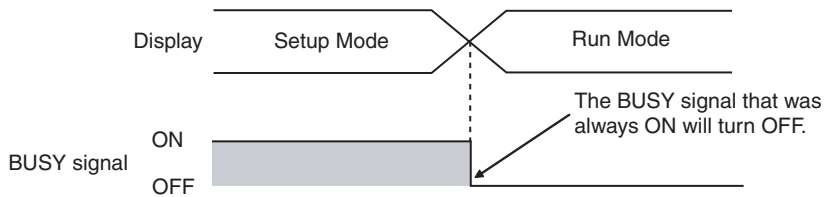

6-2 Configuring the Run Mode Display

There are six types of displays that can be used, as shown below. Select the display as desired.

Checking the Judgement Results of Inspection Items



The image and region currently being measured will appear.



In addition to [Graphics] display, individual judgement results and measurement values of selected inspection items will appear.

Checking the Overall Judgement Result History

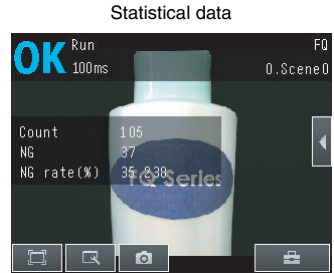

The currently measured image and history of the overall judgement results (measurement count, NG count, and NG rate) will appear.

Checking the Judgements of All Inspection Items in a List

All results/region (Standard Models Only)



The judgement results of all inspection items can be checked in a list.

Displaying Measurement Result Histories

Trend monitor



The statistical data for the currently selected inspection item can be checked against time.

Histogram



The distribution of measurement results of the currently selected inspection item can be checked.

▶ (Run Mode) – [Select display]

The following displays are convenient if more than one Sensor is connected.

Multi sensor

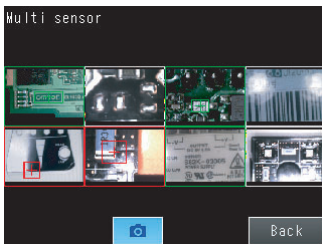

Displays the measurement results of all connected Sensors. Green display: OK, Red display: NG

NG sensor

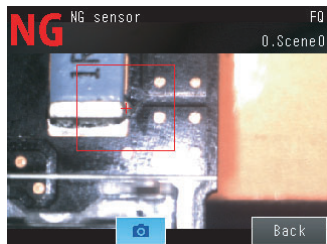

Automatically changes to the display for any Sensor with an NG result.

▶ (Run Mode) – [Sensor monitor]

Specifying the Startup Run Mode Display

The display that appears when power supply is turned ON can be set.
The default setting is [Graphics].

▶  (Setup Mode or Run Mode) – [TF settings] – [Startup display] – [Display pattern]

Displaying the Inspection Item Results

You can scroll through the measurement results of all the configured inspection items by using the following operations.

Switches to the previous inspection item.

Switches to the next inspection item.



Note

The following are also displayed in addition to the measurement results for each inspection item.

- Camera input: The image that is being measured is displayed.
- Position comp.: The result of position compensation is displayed.
- All Region: The measurement regions for all inspection items are displayed.

6-3 Adjusting Judgement Parameters during Operation

This Sensor enables judgement parameters to be adjusted while measurements are being performed. Downtime can be eliminated with this feature because the production line does not have to be stopped while making adjustments.

Preparations

This function is switched OFF as a default to prevent it from inadvertently working during operation. Turn ON the function if you want to use it.



▶ (Setup Mode) – [Sensor settings] – [Adjustment mode in Run]

- 1 Press [ON].

Changing the Judgement Parameters in Run Mode

This section describes how to change the judgement parameters without stopping measurement in Run Mode.

▶ Run Mode

- 1 Select the inspection item for which you want to adjust the judgement parameters using the  and  Buttons.
- 2 Press [] – [Adjust judgement].
- 3 Change the adjustment parameters with the slider.
- 4 Press [OK].
The judgement results with the changed judgement parameters will appear.

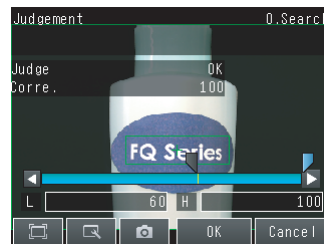
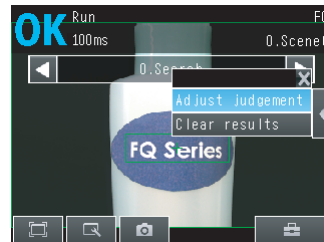

Important

The changed judgement parameters will not be reflected in the measurement result until [OK] is pressed.

Communications with External Devices

7-1 Operation with Default Configuration	60
7-2 Setting the Measurement Trigger	61
7-3 Setting the Outputs	65
7-4 Controlling the Sensor from an External Device.	68

7-1 Operation with Default Configuration

This section describes the basic connections and signal flow with external devices. With the default settings, the Sensor operates in the following manner.

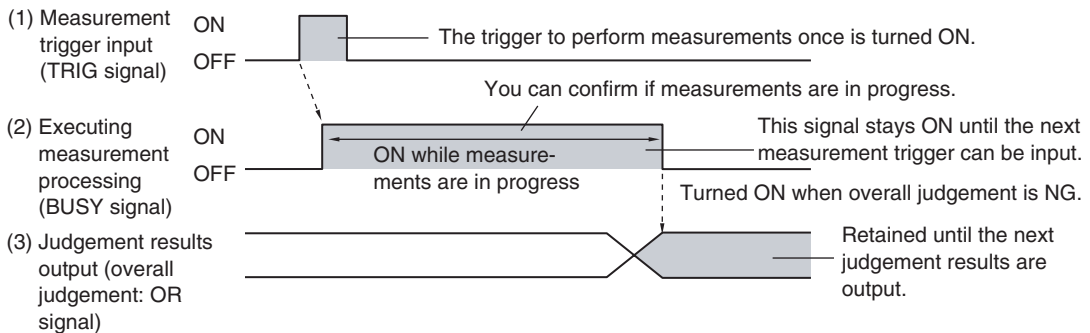
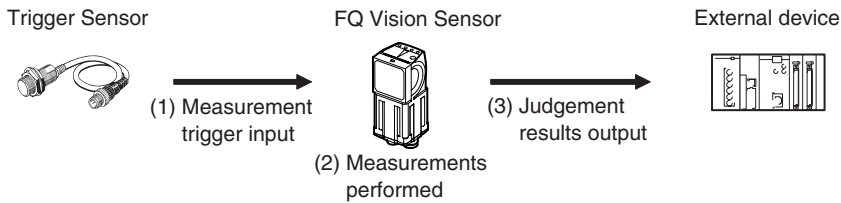

Important

- Create the ladder program to control the TRIG and IN5 input signals so that they do not turn ON while the BUSY signal is ON. If not, a TRIG input error will occur and the ERROR signal will turn ON.
- Operation When the Sensor Power Supply Is Turned ON
The BUSY signal will operate as shown below when the Sensor's power supply is turned ON. Create the ladder program in the PLC or other external device so that the BUSY signal is ignored while it turns OFF, ON, and OFF again for up to 5 s after the power supply is turned ON.

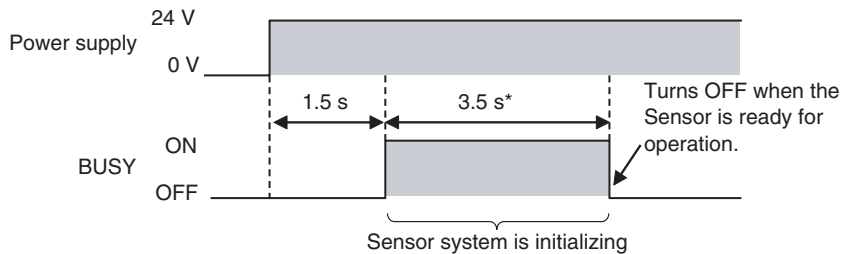

* Depends on the scene data.

Configuring the Operation

The following settings can be selected depending on the system configuration and application.

Type of change	Change	Reference
Changing the type of measurement trigger	Performing continuous measurements	p. 62
Changing the output method of the judgement results	Obtaining individual judgement results	p. 66

7-2 Setting the Measurement Trigger

The measurement trigger can be chosen from the following two types:

- One-shot measurement: One measurement is performed for each external trigger.
- Continuous measurement: Measurements are performed continuously.

Performing One Measurement for Each External Trigger

A measurement trigger is input as the TRIG signal from a proximity sensor, PLC, or other external device. One measurement is performed when the TRIG signal turns ON.

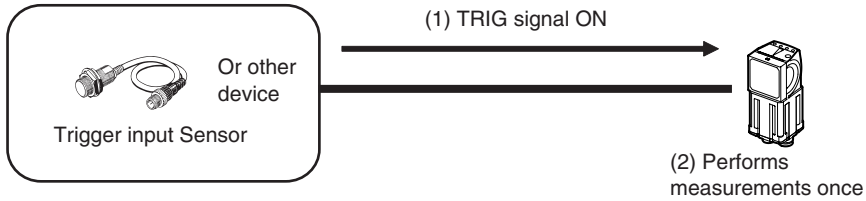

Wiring

Color	Signal	Description
Pink	TRIG	Trigger signal
Black	OUT0 (OR)	Overall judgement (default assignment)
Orange	OUT1 (BUSY)	Processing in progress (default assignment)

The signals shown at the left are used. Refer to the following information for signal wiring.



Wiring: p. 15

Timing Chart

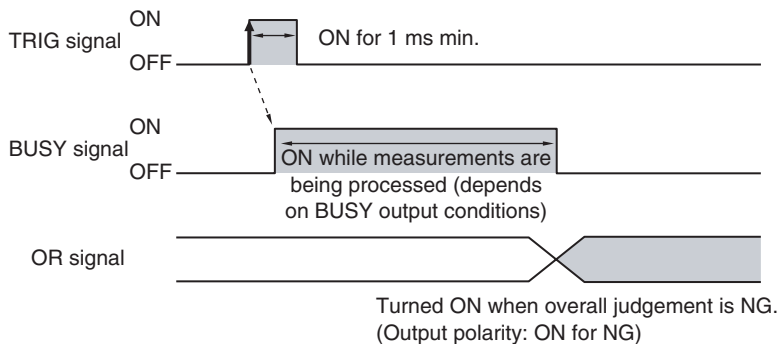

1. Turn ON the TRIG signal while the BUSY signal is OFF.
2. Measurement begins and the BUSY signal is turned ON during the measurement process.
3. When the measurement has been finished, the measurement result is output using an OR signal, and the BUSY signal is turned OFF. *1

*1: You can also set the signal to be turned OFF after data logging, image logging, or displaying results in the [BUSY output].

Sample Ladder Program

The following sample program is used to input a TRIG signal to perform a single measurement. A single measurement will be performed when W0.00 turns ON.

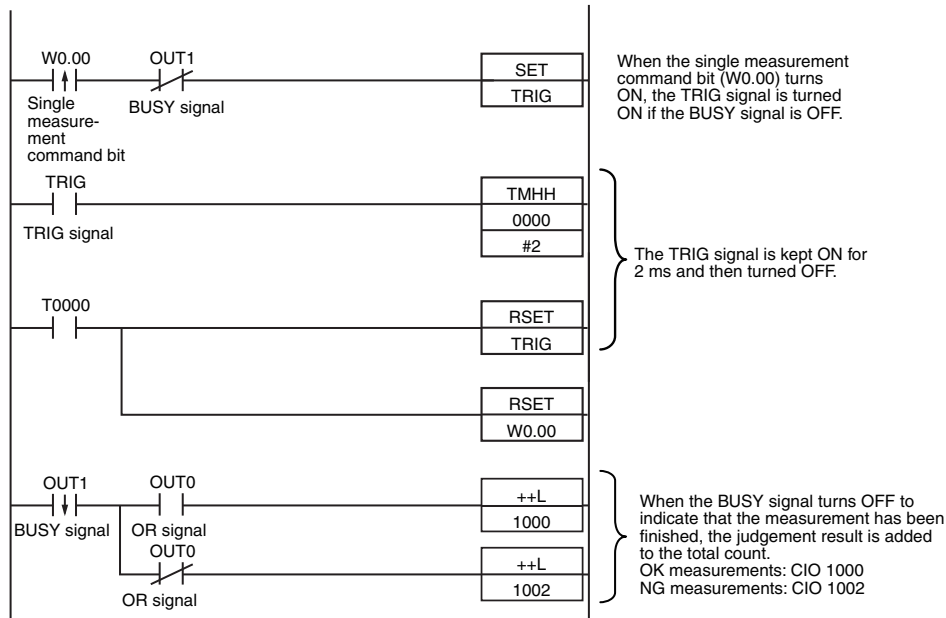

I/O Signal Allocations

Signal	Address	
Output signals	OUT0 (OR signal)	CIO 0.00
	OUT1 (BUSY signal)	CIO 0.01
Input signals	TRIG	CIO 1.00

Important

The BUSY signal will remain ON while the measurement is being executed.

Performing Continuous Measurements

Continuous measurements are performed while the continuous measurement command is input from an external device.

Immediately after a measurement is performed, the next measurement is performed.

This is repeated while a continuous measurement command is input with the IN0 to IN5 signals.

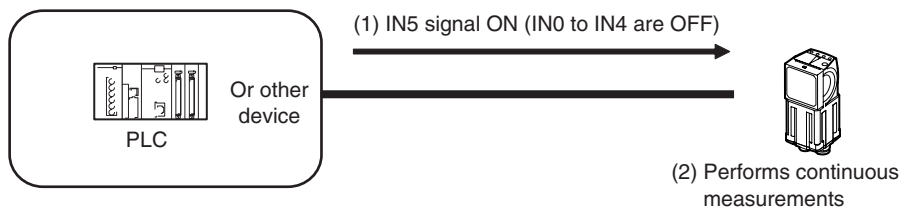

Note

This function can be used only when the input mode is set to Expanded Mode.

Wiring

Color	Signal	State	Description
Gray	IN0	OFF	Command parameters for continuous measurements
Green	IN1	OFF	
Red	IN2	OFF	
White	IN3	OFF	
Purple	IN4	OFF	
Yellow	IN5	ON	Command input for continuous measurements
Black	OUT0 (OR)	--	Overall judgement (default assignment)
Orange	OUT1 (BUSY)	--	Processing in progress (default assignment)

The signals shown at the left are used. Refer to the following information for signal wiring.



Wiring: p. 15

Timing Chart

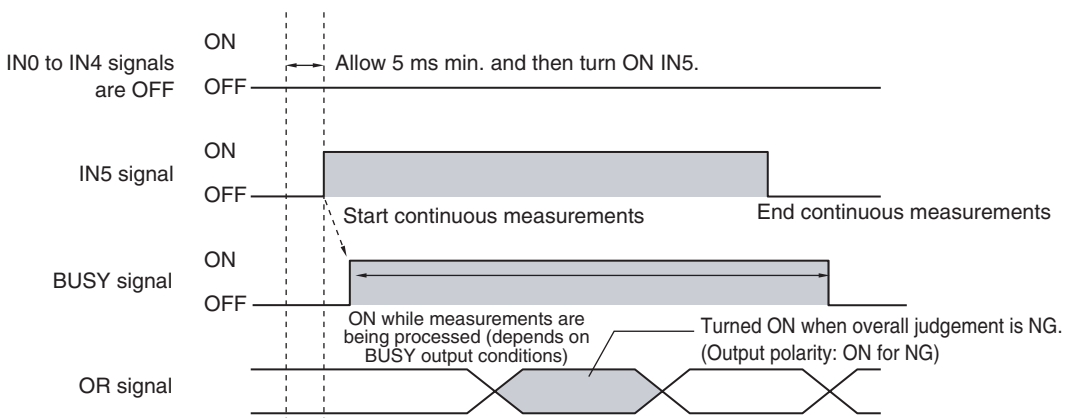

1. Turn ON IN5 while IN0 to IN4 are OFF. If status is held while the BUSY signal is OFF, continuous measurements will begin and the BUSY signal will remain ON while continuous measurements are being performed.
2. Continuous measurements end when IN5 is turned OFF.

Settings

► [In/Out] – [I/O setting] – [Input] – [Input mode]

Press [Expanded mode].

Sample Ladder Program

The following sample program is used to input a IN5 signal to perform continuous measurements. Continuous measurements will be started when W0.00 turns ON and stopped when W0.01 turns ON.

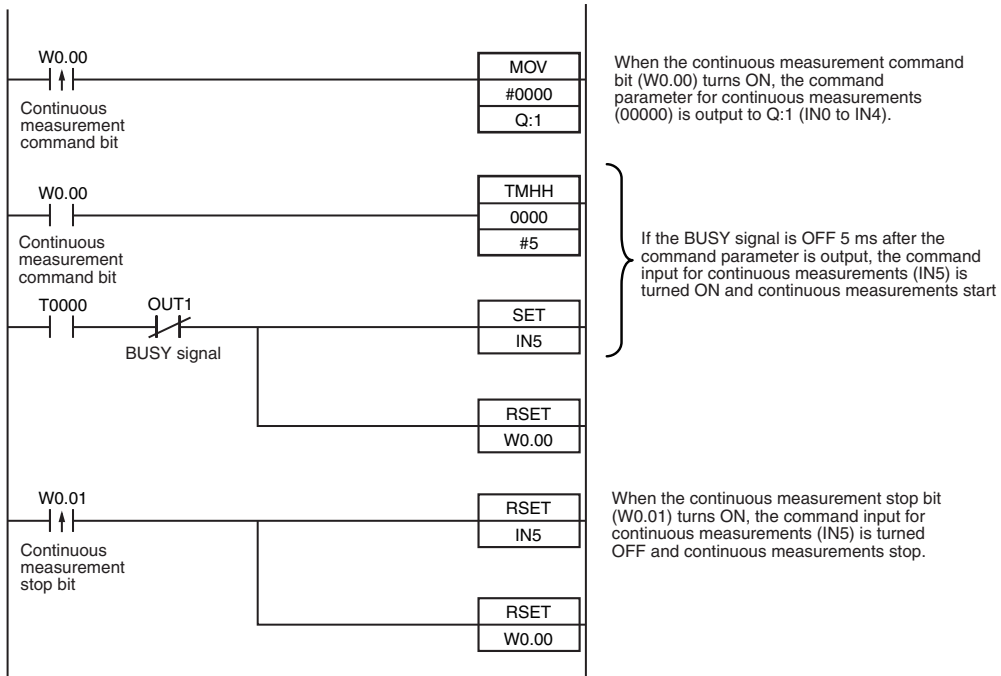

I/O Signal Allocations

Signal		Address
Output signals	OUT1 (BUSY signal)	CIO 0.01
Input signals	IN0	CIO 1.08
	IN1	CIO 1.09
	IN2	CIO 1.10
	IN3	CIO 1.11
	IN4	CIO 1.12
	IN5	CIO 1.15

7-3 Setting the Outputs

Using the Overall Judgement Result

When the results of the inspection items are judged, if even one individual judgement result is NG, the OR output signal is turned ON.

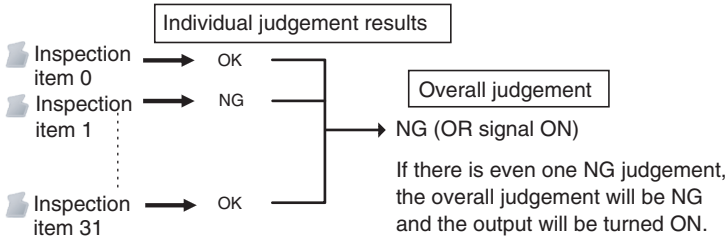

Wiring

Color	Signal	Description
Black	OUT0 (OR)	Overall judgement (default assignment)

The signals shown at the left are used. Refer to the following information for signal wiring.

2-3 Wiring: p. 15

Timing Chart

The OR signal that is output is held until the next overall judgement is output.

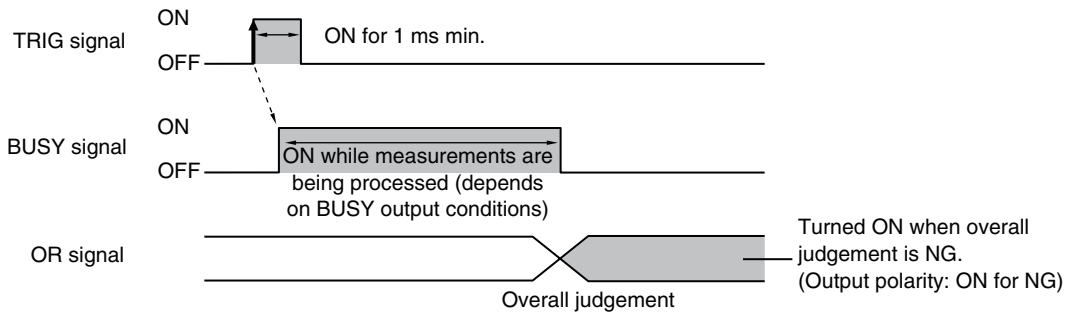

Obtaining Individual Judgement Results

Up to three judgement results of individual inspection items (individual judgement signals OR0 to OR31) can be assigned to terminals OUT0 to OUT2 and output to external devices.

Output terminal	Output signals that can be assigned
OUT0	<ul style="list-style-type: none">• OR (Total judgement)...(default)• OR0 (Item 0 judgement) to OR31 (Item 31 judgement)
OUT1	<ul style="list-style-type: none">• BUSY (default)• OR0 (Item 0 judgement) to OR31 (Item 31 judgement)
OUT2	<ul style="list-style-type: none">• ERROR (default)• OR0 (Item 0 judgement) to OR31 (Item 31 judgement)

Wiring

Example: Signals are assigned to terminals OUT0 to OUT2 as shown below.

- OUT0: Inspection number 2 (OR2)
- OUT1: Inspection number 5 (OR5)
- OUT2: Inspection number 14 (OR14)

Color	Signal	Description
Black	OUT0 (OR2)	Outputs the judgement for OR2.
Orange	OUT1 (OR5)	Outputs the judgement for OR5.
Light blue	OUT2 (OR14)	Outputs the judgement for OR14.

The signals shown at the left are used.

Refer to the following information for signal wiring.



2-3 Wiring: p. 15

As described above, if terminals OUT0 to OUT2 are all assigned to individual judgement output signals, the BUSY signal and ERROR signal assigned as the default settings will no longer be output.

Timing Chart

Output OR0 to OR31 signals are held until the next judgement output.

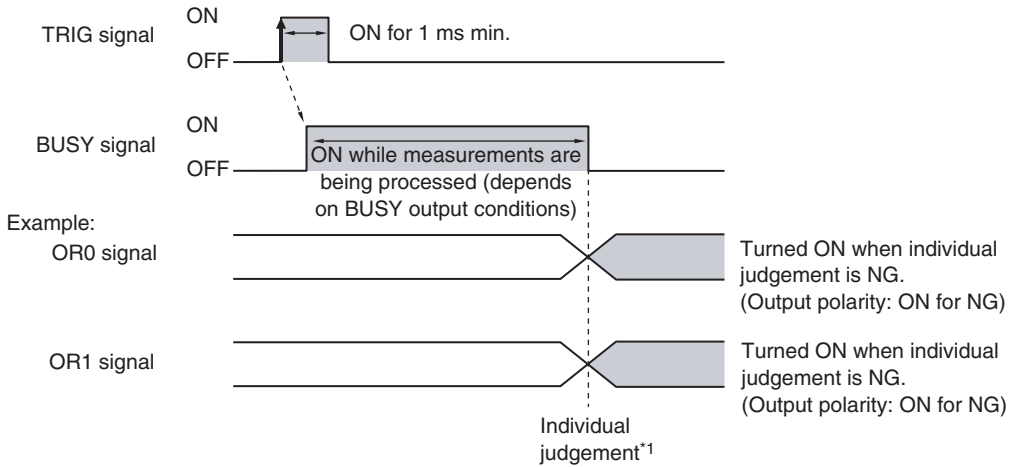

*1: The timing for updating the OR signal is when the measurement results are finalized, regardless of the output settings of the BUSY signal (BUSY output conditions).

Settings

► [In/Out] – [I/O setting] – [Output]

- 1 Press [OUT0].**
- 2 Press [OR2 (Item 2 judgement)].**
OR2 output signal was assigned to OUT0.
- 3 Assign the others in the following manner.**
OUT1: OR5
OUT2: OR14

7-4 Controlling the Sensor from an External Device

The following Sensor functions can be controlled with command inputs from an external device without connecting the Touch Finder.

Function	Description	Reference
Switching the scene	This command changes the scene when the line process changes.	p. 68
Re-registering the model or reference color	This command re-registers the judgement references for measurement when levels are changed.	p. 70
Clearing an error	This command turns the ERROR signal OFF.	p. 73
Continuous measurement	Continuous measurement is performed while this command is input.	p. 62

Changing the Scene

This section describes how to change the line process by changing the scene.

Wiring

Color	Signal	State		Description
		Input Mode		
		Standard Mode	Expanded Mode	
Gray	IN0	Scene number (0 to 31)	Scene number (0 to 15)	Specifies the scene number.
Green	IN1			
Red	IN2			
White	IN3			
Purple	IN4			
Yellow	IN5	ON		Trigger to change the scene
Orange	OUT1 (BUSY)	--		Processing in progress (default)

The signals shown at the left are used. Refer to the following information for signal wiring.



2-3 Wiring: p. 15

Timing Chart

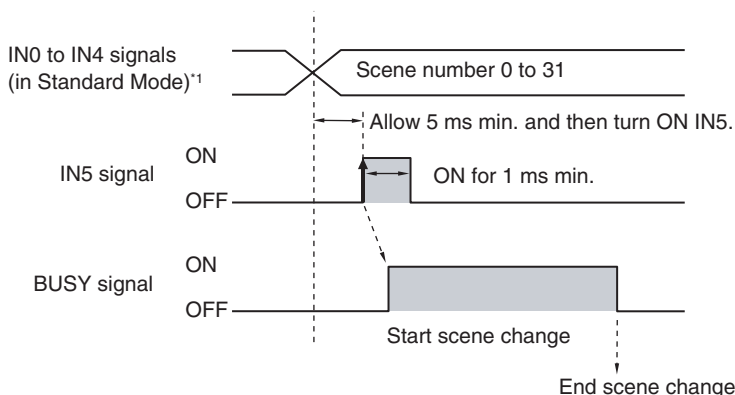

- 1 Specify the scene number with the IN0 to IN4 signals. (Standard Mode)
- 2 Turn ON the IN5 signal while the BUSY signal is ON to change the scene to the specified scene.
- 3 The BUSY signal turns ON while the scene is being switched.

*1: In Expanded Mode, specify scene numbers 0 to 15 using the IN0 to IN3 signals.

Settings

► [In/Out] – [I/O setting] – [Input] – [Input mode]

The scene numbers that can be used depend on the input mode.

[Standard mode] (default): Scene 0 to 31

[Expanded mode]: Scene 0 to 15

Sample Ladder Program

This sample program is used to change the scene when the input mode is set to Expanded Mode. The scene changes to scene 1 when W0.00 turns ON.

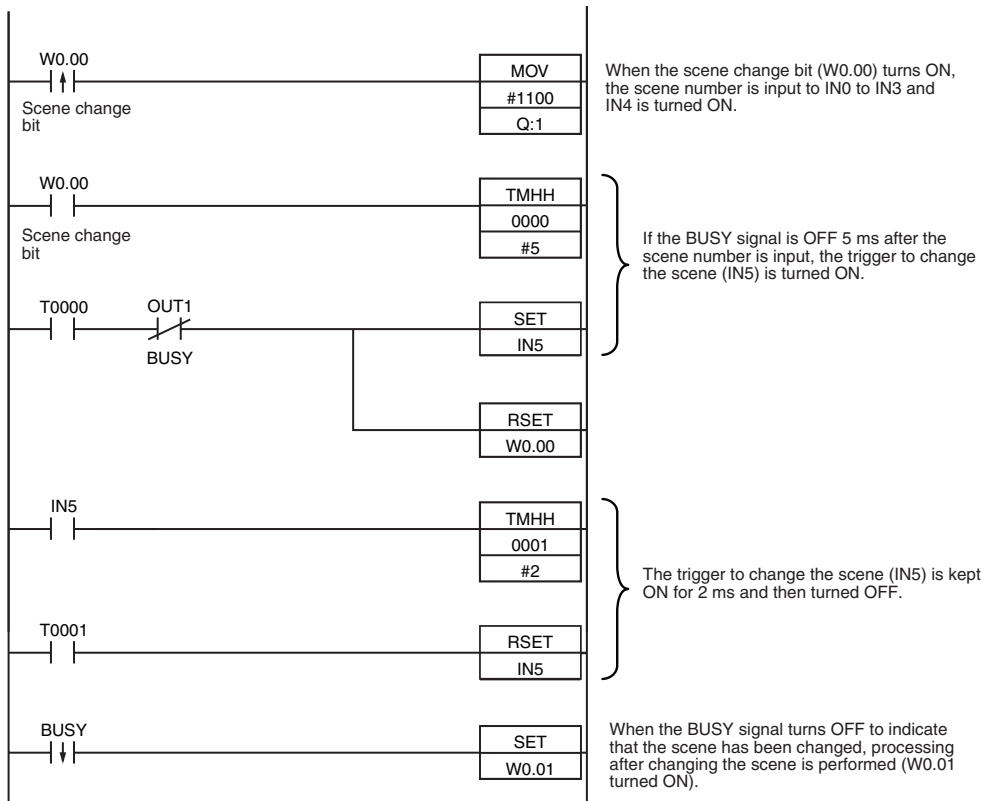

I/O Signal Allocations

Signal	Address	
Output signals	OUT1 (BUSY signal)	CIO 0.01
Input signals	IN0	CIO 1.08
	IN1	CIO 1.09
	IN2	CIO 1.10
	IN3	CIO 1.11
	IN4	CIO 1.12
	IN5	CIO 1.15

Note

The BUSY signal will be ON while the scene it being changed.

Important

If the cycle time is too long, the PLC may not be able to detect when the BUSY signal is ON. If necessary, turn OFF W0.00 after a suitable time elapses.

Registering the Measurement Reference Again

The model and reference color can be re-registered with commands from an external device, such as a PLC, based on the image that was just input when the line process was changed.

Inspection item	Re-registered data
Search	Model data
Color data	Reference color (hue, saturation, and brightness)
Edge Position, Edge Width, Area	None

Note

- Application is possibly only from the Run Mode
- If the parameter is applicable to more than one inspection item, it will be re-registered for all inspection items.

Settings

► [In/Out] – [I/O setting] – [Input] – [Input mode]

Press [Expand mode].

Wiring

Color	Signal	State	Description
Gray	IN0	OFF	Command parameter for registering the model again
Green	IN1	OFF	
Red	IN2	OFF	
White	IN3	ON	
Purple	IN4	OFF	
Yellow	IN5	ON	Command input for registering the model again
Orange	OUT1 (BUSY)	--	Processing in progress (default)

The signals shown at the left are used.

Refer to the following information for signal wiring.



2-3 Wiring: p. 15

Timing Chart

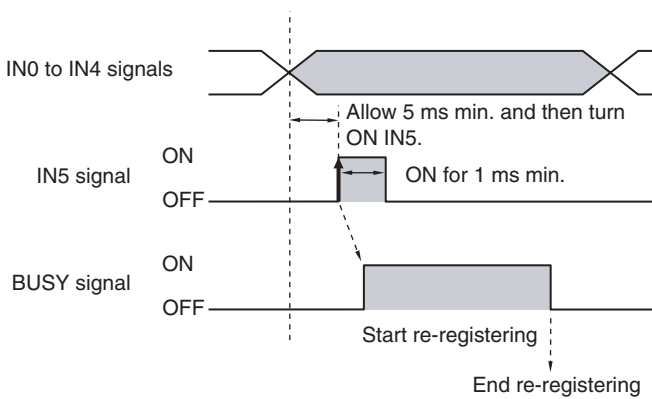

- 1 Turn OFF IN 0 to IN4 and turn ON IN3.
- 2 Turn ON the IN5 signal while the BUSY signal is OFF to register the model data and reference color again from the image that was just input.
- 3 The BUSY signal turns ON while the parameters are being re-registered.

Sample Ladder Program

This sample program is used to input IN5 to re-register a model.

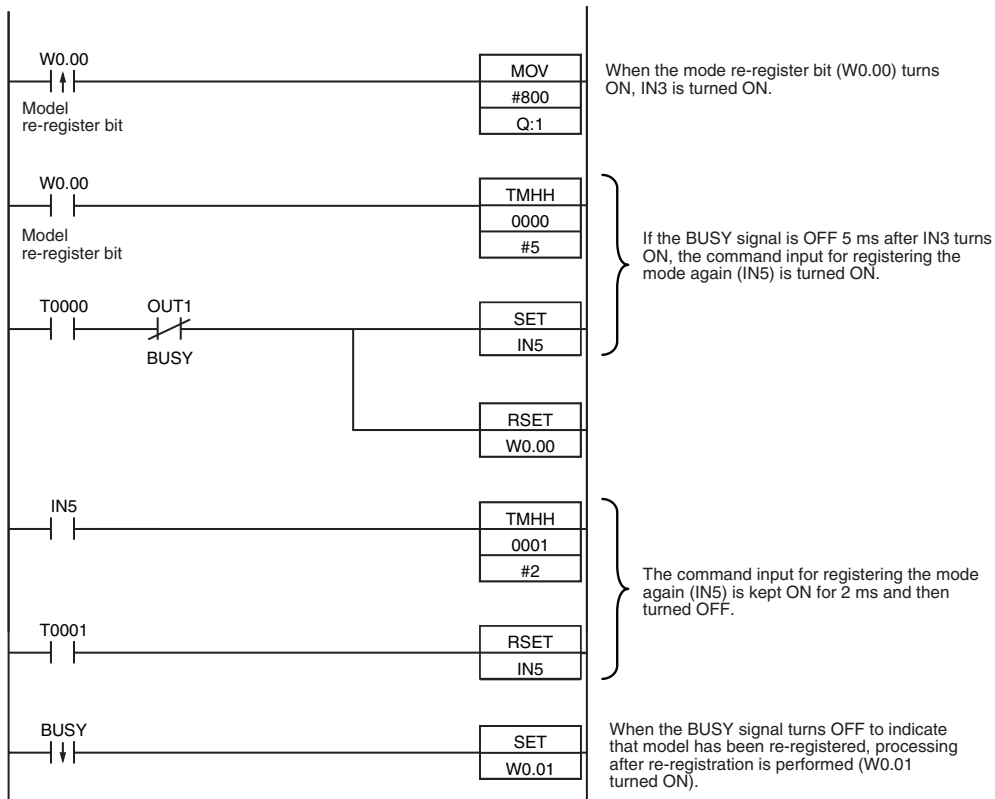

I/O Signal Allocations

Signal		Address
Output signals	OUT1 (BUSY signal)	CIO 0.01
Input signals	IN0	CIO 1.08
	IN1	CIO 1.09
	IN2	CIO 1.10
	IN3	CIO 1.11
	IN4	CIO 1.12
	IN5	CIO 1.15

Note

The BUSY signal will be ON while the model is being re-registered.

Important

If the cycle time is too long, the PLC may not be able to detect when the BUSY signal is ON. If necessary, turn OFF W0.00 after a suitable time elapses.

Turning the ERROR Signal OFF

The ERROR signal turns ON when an error occurs.

After removing the cause of the error, turn the ERROR signal OFF using one of the following methods.

Method 1: Input an error clear command from an external device such as a PLC.

Method 2: Input a measurement trigger again.

(For example, turn the TRIG signal ON during a one-shot measurement.)

The ERROR signal will turn OFF when measurement is executed correctly.

Note

This function can be used in Run Mode only.

Settings

► [In/Out] – [I/O setting] – [Input] – [Input mode]

Press [Expand mode].

Wiring

Color	Signal	State	Description
Gray	IN0	OFF	Command parameter for clearing errors
Green	IN1	OFF	
Red	IN2	ON	
White	IN3	OFF	
Purple	IN4	OFF	
Yellow	IN5	ON	Command input for clearing errors
Orange	OUT1 (BUSY)	--	Processing in progress (default)
Light blue	OUT2 (ERROR)	--	ERROR signal (default)

The signals shown at the left are used.

Refer to the following information for signal wiring.



2-3 Wiring: p. 15

Timing Chart

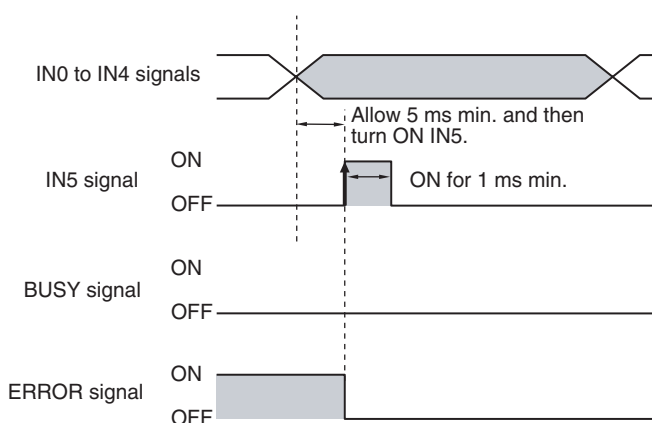

1 Turn OFF IN0 to IN1 and IN3 to IN4 and turn ON IN2.

2 Turn ON the IN5 signal while the BUSY signal is OFF to clear the error.

Revision History

A manual revision code appears as a suffix to the catalog number at the bottom of the front and back covers of this manual.

Cat. No. Z306-E1-02A

↑
Revision code

Revision code	Date	Revised contents
01	August 2010	Original production
02	September 2010	Additions for version upgrade (version 1.10).
02A	October 2010	Minor corrections (p.10,65)